



Blending Hydrogen into Natural Gas Pipeline Networks: A Review of Key Issues

M. W. Melaina, O. Antonia, and M. Penev

NREL is a national laboratory of the U.S. Department of Energy, Office of Energy Efficiency & Renewable Energy, operated by the Alliance for Sustainable Energy, LLC.

Technical Report
NREL/TP-5600-51995
March 2013

Contract No. DE-AC36-08GO28308

Blending Hydrogen into Natural Gas Pipeline Networks: A Review of Key Issues

M. W. Melaina, O. Antonia, and M. Penev

Prepared under Task No. HT12.2010

NREL is a national laboratory of the U.S. Department of Energy, Office of Energy Efficiency & Renewable Energy, operated by the Alliance for Sustainable Energy, LLC.

NOTICE

This report was prepared as an account of work sponsored by an agency of the United States government. Neither the United States government nor any agency thereof, nor any of their employees, makes any warranty, express or implied, or assumes any legal liability or responsibility for the accuracy, completeness, or usefulness of any information, apparatus, product, or process disclosed, or represents that its use would not infringe privately owned rights. Reference herein to any specific commercial product, process, or service by trade name, trademark, manufacturer, or otherwise does not necessarily constitute or imply its endorsement, recommendation, or favoring by the United States government or any agency thereof. The views and opinions of authors expressed herein do not necessarily state or reflect those of the United States government or any agency thereof.

Available electronically at <http://www.osti.gov/bridge>

Available for a processing fee to U.S. Department of Energy and its contractors, in paper, from:

U.S. Department of Energy
Office of Scientific and Technical Information
P.O. Box 62
Oak Ridge, TN 37831-0062
phone: 865.576.8401
fax: 865.576.5728
email: <mailto:reports@adonis.osti.gov>

Available for sale to the public, in paper, from:

U.S. Department of Commerce
National Technical Information Service
5285 Port Royal Road
Springfield, VA 22161
phone: 800.553.6847
fax: 703.605.6900
email: orders@ntis.fedworld.gov
online ordering: <http://www.ntis.gov/help/ordermethods.aspx>

Cover Photos: (left to right) PIX 16416, PIX 17423, PIX 16560, PIX 17613, PIX 17436, PIX 17721



Printed on paper containing at least 50% wastepaper, including 10% post consumer waste.

Acknowledgments

Funding for this report came from the U.S. Department of Energy's Fuel Cell Technologies Program. The authors thank Daniel Ersoy and Zhongquan Zhou from the Gas Technology Institute (GTI) for preparing the subcontract report, included as Appendix A. The report has benefited greatly due to comments received from multiple reviewers of an earlier version. Specifically, we thank Glen Eisman (H2Pump LLC), Onno Florisson (KEMA, European NaturalHy Project), Edward Heydorn (Air Products and Chemicals, Inc.), Noel Leeson (Power & Energy Inc.), and Frank Lomax (CB&I Lummus Technology).

Definitions

atm	atmosphere
CCS	carbon capture and storage
DTI	Directed Technologies, Inc.
EHS	electrochemical hydrogen separation
FERC	Federal Energy Regulatory Commission
GTI	Gas Technology Institute
HDS	hydro-desulfurization
IEA	International Energy Agency
IMP	Integrity Management Program
IMT	Integrity Management Tool
in.	inch, inches
ISQ	Instituto de Soldadura e Qualidade
m	meter
NREL	National Renewable Energy Laboratory
PBI	polybenzimidazole
Pd	palladium
PE	polyethylene
PEM	proton exchange membrane
PHMSA	Pipeline and Hazardous Materials Safety Administration
ppb	parts per billion
ppm	parts per million
ppmv	parts per million by volume
PSA	pressure swing absorption
psi	pounds per square inch
psia	pounds per square inch absolute
psig	pounds per square inch gauge
PVC	polyvinyl chloride
SMR	steam methane reforming

Executive Summary

Hydrogen is being pursued as a sustainable energy carrier for fuel cell electric vehicles (FCEVs) and as a means of storing renewable energy at utility scale. Hydrogen can also be used as a fuel in stationary fuel cell systems for buildings, backup power, or distributed generation. Blending hydrogen into the existing natural gas pipeline network has been proposed as a means of increasing the output of renewable energy systems such as large wind farms. If implemented with relatively low concentrations, less than 5%–15% hydrogen by volume, this strategy of storing and delivering renewable energy to markets appears to be viable without significantly increasing risks associated with utilization of the gas blend in end-use devices (such as household appliances), overall public safety, or the durability and integrity of the existing natural gas pipeline network. However, the appropriate blend concentration may vary significantly between pipeline network systems and natural gas compositions and must therefore be assessed on a case-by-case basis. Any introduction of a hydrogen blend concentration would require extensive study, testing, and modifications to existing pipeline monitoring and maintenance practices (e.g., integrity management systems). Additional cost would be incurred as a result, and this cost must be weighed against the benefit of providing a more sustainable and low-carbon gas product to consumers.

Blending hydrogen into natural gas pipeline networks has also been proposed as a means of delivering pure hydrogen to markets, using separation and purification technologies downstream to extract hydrogen from the natural gas blend close to the point of end use. As a hydrogen delivery method, blending can defray the cost of building dedicated hydrogen pipelines or other costly delivery infrastructure during the early market development phase. This hydrogen delivery strategy also incurs additional costs, associated with blending and extraction, as well as modifications to existing pipeline integrity management systems, and these must be weighed against alternative means of bringing more sustainable and low-carbon energy to consumers.

Though the concept of blending hydrogen with natural gas is not new (IGT 1972), the rapid growth in installed wind power capacity and interest in the near-term market readiness of FCEVs has made blending a more tangible consideration within several stakeholder activities (Florisson 2012; GM 2010), including recent agreements on “Power-to-Gas” initiatives with Hydrogenics (2012a; 2012b). Delivering blends of hydrogen and methane (the primary component of natural gas) by pipeline also has a long history, dating back to the origins of today’s natural gas system when manufactured gas produced from coal was first piped during the Gaslight era to streetlamps, commercial buildings, and households in the early and mid-1800s. The manufactured gas products of the time, also referred to as town gas or water gas, typically contained 30%–50% hydrogen, and could be produced from pitch, whale oil, coal or petroleum products (Castaneda 1999; Tarr 2004; Melaina 2012). The use of manufactured gas persisted in the United States into the early 1950s, when the last manufactured gas plant in New York was shut down and natural gas had displaced all major U.S. manufactured gas production facilities. In some urban areas, such as Honolulu, Hawaii, manufactured gas continues to be delivered with significant hydrogen blends and is used in heating and lighting applications as an economic alternative to natural gas (TGC 2012; GM 2010).

This report reviews seven key issues related to blending hydrogen into natural gas pipeline networks, which are described briefly in the following sections. Though these issues are interrelated, they are presented separately for the sake of clarifying explanation:

1. Benefits of blending
2. Extent of the U.S. natural gas pipeline network
3. Impact on end-use systems
4. Safety
5. Material durability and integrity management
6. Leakage
7. Downstream extraction

The review material presented in this report relies heavily on a study from the Gas Technology Institute (GTI), which is included as Appendix A. While conventional means of producing and delivering hydrogen are relatively well understood, blending as a means of storing or delivering hydrogen is very dependent on specific characteristics of the natural gas pipeline system. The GTI assessment therefore details the implications of hydrogen blending in relation to the distinct characteristics of the U.S. natural gas pipeline system. This report also relies on the extensive studies conducted within the *NaturalHy* project, associated with the Sixth Framework Programme of the European Commission (Florisson 2012), as well as information from a Greenhouse Gas R&D Programme study sponsored by the International Energy Agency (IEA) (Haines et al. 2003).

Benefits of Blending

Adding hydrogen to natural gas can significantly reduce greenhouse gas emissions if the hydrogen is produced from low-carbon energy sources such as biomass, solar, wind, nuclear, or fossil resources with carbon capture and storage (CCS). Any social or environmental benefits associated with sustainable hydrogen pathways could arguably be attributed to natural gas with a hydrogen blend component in proportion to the hydrogen concentration. In the downstream extraction pathway, use of hydrogen in FCEVs improves air quality by reducing sulfur dioxide, oxides of nitrogen, and particulate emissions and displacing conventional gasoline or diesel fuels. The blending benefit would be similar, in some respects, to the introduction of biogas into the natural gas pipeline as a means of providing a renewable natural gas product to consumers. Conceivably, a credit trading system could apply to natural gas with a specified blend content of renewable hydrogen, paralleling the renewable energy credit system used in the electricity sector. If properly crafted, this credit system could provide an economic incentive for converting otherwise curtailed renewable energy to hydrogen, increasing the energy provided from existing renewable energy production facilities, and enhancing the sustainability of the natural gas supply system. Understanding the techno-economic potential and spatial logistics associated with this type of energy storage and hydrogen delivery system would require additional analysis. Recent efforts to develop such a system in Germany will provide useful empirical data to understand better the potential to apply renewable credits to hydrogen and natural gas blends (Wilson 2012; E.ON 2011).

Extent of the U.S. Natural Gas Pipeline Network

The U.S. natural gas pipeline system has evolved from local manufactured gas networks serving municipalities in the mid-1800s to a vast network of interconnected pipeline systems comprising 2.44 million miles of pipe, 400 underground storage facilities, and 1,400 compressor stations. Natural gas accounted for 24.6 quads of U.S. energy consumption in 2010, roughly 25% of total energy consumed. Moreover, recent increased domestic production rates suggest that the existing natural gas system will continue to provide relatively clean and domestic energy for some time, especially with increased adoption of energy efficiency measures (EIA 2012). Given these characteristics, hydrogen blending could become a widespread, long-term, and integral practice to supplement a critical domestic energy infrastructure.

Impact on End-Use Systems

Several studies have discussed the issue of maximum hydrogen blend levels at which no or minor modifications would be needed for end-use systems, including appliances such as household boilers or stoves and industrial or power generation (Florisson 2010; De Vries 2009; Haeseldonckx 2007; De Vries 2007; Schumra and Klingenberg 2005; Kelly and Hagler 1980). The conditions determining a maximum hydrogen blend level that does not adversely influence appliance operation or safety vary significantly and include the composition of the natural gas, the type of appliance (or engine), and the age of the appliance. The impact of hydrogen blends on industrial facilities must be addressed on a case-by-case basis, and stationary gas engines likely will require changes to control systems (Florisson 2010). Ranges noted as being acceptable generally for end-use systems fall within 5%–20% hydrogen, and most discussions note types of changes, precautions, or costs associated with higher blends. For example, Haines et al. (2003) estimate the cost of upgrades in the United Kingdom, Netherlands, and France with respect to modifications required for 3%, 12%, and 25% hydrogen blends. Given the inertia behind any required changes to end-user appliances or industrial facilities, hydrogen blending likely would begin at very low concentrations and then increase gradually over time (if warranted) as required modifications for higher concentrations are addressed. As noted by Florisson (2009), end-use requirements are generally the most restrictive conditions on increasing hydrogen blend levels in natural gas. The natural gas composition in a given pipeline is an important consideration (Zachariah-Wolff et al. 2007). Meeting these requirements would often preclude risks posed by safety and material integrity concerns.

Safety

Multiple factors must be taken into consideration to assess the safety concerns associated with blending hydrogen into the existing U.S. natural gas pipeline system. It is difficult to make general claims about safety due to the large number of factors involved; detailed risk assessment results likely will vary from location to location. Because hydrogen has a broader range of conditions under which it will ignite, a main concern is the potential for increased probability of ignition and resulting damage compared to the risk posed by natural gas without a hydrogen blend component. The probability of an incident and the consequence of the incident are combined into an overall risk factor. In the literature reviewed, these risk factors have been assessed for hydrogen blends of various concentrations (e.g., 20%, 25%, and 50%), for different sections of the existing natural gas pipeline system (e.g., distribution mains and service lines), and for different conditions (e.g., contained or uncontained releases). The context for describing safety concerns is therefore the degree to which different types of hazards may increase or

decrease risks for different hydrogen concentrations, pipeline types, and failure mode conditions. The risk assessment results described here would not apply to new, dedicated hydrogen pipelines carrying pure hydrogen, and blending risks will vary between natural gas pipeline systems of different types, materials, and ages across the United States.

It is important to place energy-related risks into perspective. All large-scale energy systems—including nuclear, fossil fuel and renewable energy systems—present different types of risks to human health and the environment (Schneider 1979; Holdren et al. 1979). The overall risks posed by the existing natural gas pipeline system can be quantified, and these results are used as a baseline for comparing risks associated with hydrogen blends. However, in general, natural gas systems pose a lower risk of severe accidents than do other large-scale energy systems such as coal, petroleum, nuclear, and hydropower (the latter two involving less frequent but higher impact accidents), although they appear to pose greater risk than non-hydro renewables such as wind and solar (Hirschberg et al. 2004; Bergherr and Hirschberg 2008; Bergherr et al. 2012; PSI 2012).

The present study reviews new analysis conducted by GTI of various safety hazards with reference to a numerical risk assessment scale with rankings that range from zero (no significant hazard) to 50 (severe hazard). Within this numerical system, a hazard significance ranking of 10 is described as “minor,” 30 is “moderate,” and 50 is “severe” (see Appendix A). Though actual rankings may vary based on multiple factors, the general conclusion of the research findings presented here is that adding low concentrations of hydrogen to existing natural gas pipeline systems, at volumes of 20% or less, results in a minor increase in the risk of ignition. Moreover, in instances where natural gas leaks result in explosions, inclusion of 20% or less hydrogen would result in minor increases in the severity of the explosion. Higher concentrations of hydrogen may be acceptable from a safety perspective in transmission lines upstream from distribution lines and city gate metering and pressure regulation stations.

As in any risk assessment, it is important to understand the conditions under which risks are being assessed. The GTI assessment presented here is based upon data specific to the U.S. natural gas supply system. Findings suggest that higher concentrations of hydrogen in distribution mains, up to 50%, present a minor increase in overall risk (including probability and severity). Risks associated with service lines are different because service lines are often found in confined spaces where leaked gas would be more likely to accumulate. If hydrogen concentrations exceed 20% in service lines, the increase in overall risk is more significant than for distribution mains. For both distribution mains and service lines, proper risk management practices, such as the installation of monitoring devices, reduces overall risk. However, adding more than 50% hydrogen to either distribution mains or service lines results in a significant increase in overall risk. Again, these risk results are associated with introducing hydrogen blends into the existing U.S. natural gas pipeline system and do not apply to new, dedicated hydrogen pipelines carrying pure hydrogen, which would be designed and managed differently than the existing natural gas pipeline system.

Material Durability and Integrity Management

The durability of some metal pipes can degrade when they are exposed to hydrogen over long periods, particularly with hydrogen in high concentrations and at high pressures. This effect may be of concern for cases where hydrogen is injected at high concentrations into existing high-

pressure natural gas transmission lines. The effect is highly dependent on the type of steel and must be assessed on a case-by-case basis. However, metallic pipes in U.S. distribution systems are primarily made of low-strength steel, typically API 5L A, B, X42, and X46, and these are generally not susceptible to hydrogen-induced embrittlement under normal operating conditions. At the pressures and stress levels occurring in the natural gas distribution system, hydrogen-induced failures are not major integrity concerns for steel pipes. For the other metallic pipes—including ductile iron, cast and wrought iron, and copper pipes—there is no concern of hydrogen damage under general operating conditions in natural gas distribution systems. There is also no major concern about the hydrogen aging effect on polyethylene (PE) or polyvinylchloride (PVC) pipe materials. Most of the elastomeric materials used in distribution systems are also compatible with hydrogen. These topics are reviewed in Appendix A.

Hydrogen blends can influence the accuracy of existing gas meters. The deviation of a gas meter with hydrogen blends varies with the meter design. This deviation was found to be acceptable based on the requirement for recalibration (less than 4%) when a gas mixture containing less than 50% hydrogen is being measured. It is anticipated that meters would not need to be tuned under low hydrogen blend levels (less than 50%) in natural gas (Appendix A). One of the remaining gaps in durability research is the need to study the potential impact of contaminants in hydrogen gas that might be introduced into the network. This would be an issue in cases where the hydrogen production system does not produce pure hydrogen.

In most research programs, the focus of integrity management has been on transmission pipelines because of concerns at high operating pressures, up to 2,000 psi (139 bar), and the pipeline steels that are subject to hydrogen-induced cracking. Hydrogen can be carried by existing natural gas transmission pipelines with only minor adaptations to the current Integrity Management Program (IMP) (Appendix A). The adaptations needed depend on hydrogen concentration and operating conditions of the individual pipelines. These are generally insignificant with concentrations up to 50% hydrogen, but a detailed investigation for every case is mandatory and could result in the upper limitation on hydrogen concentration being reduced (Appendix A).

Natural gas distribution systems are very different from transmission pipelines, and the integrity program for transmission pipelines does not apply to distribution systems. One important difference between distribution systems and transmission pipelines is location with respect to populated areas. The level of hydrogen that is acceptable for transmission pipelines may need to be reassessed for distribution systems in terms of the frequency and severity of fire or explosion in a highly populated area. In addition, the hazards arising from gas leakage in a distribution system may be more severe than in transmission pipelines, especially in a confined service area. The integrity management for distribution systems under hydrogen services may require a leak detector or a monitoring device or sensor. The maintenance costs for distribution systems under hydrogen service likely will increase because these systems will need to be inspected more frequently and likely will require additional leak detection systems. Florisson et al. (2010) outline general conclusions of detailed studies of both durability and integrity issues, and they estimate that modifications to existing integrity management practices may incur an additional 10% cost increase due to hydrogen blends.

Leakage

Hydrogen is more mobile than methane in many polymer materials, including the plastic pipes and elastomeric seals used in natural gas distribution systems. The permeation coefficient of hydrogen is higher through most elastomeric sealing materials than through plastic pipe materials. However, pipes have much larger surface areas than seals, so leaks through plastic pipe walls would account for the majority of gas losses (Appendix A). Permeation rates for hydrogen are about 4 to 5 times faster than for methane in typical polymer pipes used in the U.S. natural gas distribution system. Leakage in steel and ductile iron systems mainly occurs through threads or mechanical joints. Leakage measurements from GTI for steel and ductile iron gas distribution systems (including seals and joints) suggest that the volume leakage rate for hydrogen is about a factor of 3 higher than that for natural gas (Appendix A).

A calculation based on literature data for the permeation coefficient of hydrogen and methane in polyethylene (PE) pipes suggests that most gas loss would occur through the pipe wall, rather than through joints, in distribution mains smaller than 2 in. and operating at 60 psig (5 bar) or higher. Extending this calculation to the larger pipeline network suggests that use of a 20% hydrogen blend within the approximately 415,000 miles of PE pipes in the United States would result in a gas loss of about 43 million ft³/yr, with about 60% of the losses being hydrogen and 40% being natural gas (Appendix A). Though this estimate of gas loss is almost twice the total gas loss for systems delivering natural gas only, it is still considered economically insignificant. As reference, this theoretical distribution main leakage rate (43 million ft³/yr) would be 0.0002% of the 24.13 trillion cubic feet of natural gas consumed in 2010 (EIA 2011). Furthermore, this calculation likely overestimates actual gas loss because the permeation coefficient taken from the literature is considered larger than those observed in experiments using pipe under actual operating pressures, especially at lower pressures. In general, hydrogen blends would slightly reduce natural gas leakage due to the higher mobility of hydrogen molecules, resulting in a net reduction in the greenhouse gas impact due to leakage. A calculation for the Dutch pipeline system, based upon experimentally derived permeation coefficients, predicts a gas leakage rate of 0.00005% with a 17% hydrogen blend (Haines et al. 2003). Further investigation and additional empirical data would be necessary to provide more accurate gas loss estimates associated with hydrogen blends.

Though gas loss from service lines is economically negligible, leakage into confined spaces may pose a safety risk. Gas leakage from elastomeric seals at joints in service lines may also increase the risk in confined spaces, and this topic warrants additional risk assessment. Further investigation into specific pipe and seal materials and systems can provide a basis to estimate gas leakage more accurately. This basis can be used to determine whether leakage in confined spaces might present a safety risk over time and the degree to which detection and monitoring devices may be required to manage risks.

Downstream Extraction

Three gas-separation technologies that could be used to extract hydrogen from mixtures in natural gas pipelines have been reviewed: pressure swing adsorption (PSA), membrane separation, and electrochemical hydrogen separation (EHS, or hydrogen pumping). PSA units operating on low hydrogen concentrations, such as 20% mixtures, are feasible. However, these units are sized for the impurities in the gas, so with low hydrogen concentrations, the PSA units

become very large. PSA units appear to be economically practical only at pipeline pressure reduction stations (i.e., pressure regulation stations) where the pressure drop is synergistic with hydrogen separation. Without this drop in pressure, uneconomically large amounts of compression energy and compressor capital would be needed to reinject hydrogen-depleted gas back into a pipeline.

Membrane separation technologies work very efficiently with relatively high concentrations of hydrogen, and the purity of the hydrogen product gas can be very high with certain membrane technologies, as they can be designed for high selectivity. Most membrane technology applications recover bulk hydrogen from industrial facilities and do not require high purity levels. Some membrane technologies, however, can realize near 100% pure hydrogen. Dilute hydrogen poses a significant challenge for membrane technology. Recovery of hydrogen with lower concentrations requires a higher pressure differential across the membrane. This means that significant volumes of non-hydrogen gas need to be compressed to high pressures in order for the hydrogen to pass through the membrane. This type of technology may be best suited for high-pressure pipelines (transmission pipelines), where the gas in the pipeline is sufficiently pressurized to allow significant recovery of hydrogen.

Electrochemical separation (also known as hydrogen pumping) is a more elaborate method for bulk hydrogen recovery. Two technologies are currently used: a Nafion-based membrane system and a polybenzimidazole (PBI) system. Nafion-based pumps have been in development longer and are considered more technologically mature, but PBI is more desirable for several reasons. One is the lower compression requirement. For a 1,000-psi pipeline, both the product gas and hydrogen would come out at essentially 1,000 psi (minus specific process pressure drop). However, while pressurization requirements are reduced, system complexity can be higher, and the technology is not as mature as PSA or some membrane technologies. Electrochemical pumping requires water to function, and addition of water involves a humidification system. On the other hand, pipeline gases have to be dry, so a water-removal system is required downstream.

Of the three separation technologies considered, PSA is the most commercially ready. Because PSA is mature and cost information is available, NREL staff estimated the cost of PSA hydrogen extraction assuming conditions for a hydrogen mixture in a distribution natural gas pipeline. Capital cost estimates for the PSA unit are based on quotes and with reference to an Nth plant concept, which reflects a mature system that is functionally reliable in the field and has been produced in sufficiently high annual and cumulative quantities to have a capital (and unit) cost approaching the technology's asymptotic lower cost limit. The cost estimate represents a future technology that may be available when hydrogen mixtures can be carried through natural gas pipelines, rather than current PSA technology. This report assesses only the cost of hydrogen extraction. The other costs (injection cost, hydrogen losses along the pipeline, underutilization during lag-in-demand seasons, analytical costs, etc.) are not accounted for here.

For a 10% concentration and 80% recovery factor, the estimated cost of hydrogen extraction by PSA from a 300 psi pipeline is \$3.3–\$8.3/kg hydrogen extracted, for a range of recovery rates of 1,000–100 kg/day. For a 20% concentration and 80% recovery factor, the extraction cost is \$2.0–\$7.4/kg hydrogen extracted, for the same range of recovery rates. These additional supply chain costs are high relative to a competitive hydrogen cost goal of \$2–\$4/kg for FCEV markets (Ruth and Joseck 2011). However, if hydrogen is extracted at a pressure-reduction facility, the high

cost of recompressing the natural gas to the original natural gas pipeline pressure can be avoided. The resulting estimated extraction cost for a 10% concentration and 80% recovery factor is \$0.3–\$1.3/kg, with the range resulting from economies of scale for a system size or recovery rate of 1,000–100 kg/day (see Figure 18). These costs per kilogram are reduced by approximately 10% if the hydrogen concentration is increased to 20%. PSA extraction could therefore become a relatively small cost component of the total delivered cost of hydrogen if the extraction is done at a pressure-reduction facility. With major pressure reduction stations often located near large urban areas, downstream extraction could prove to be an economical delivery option. It has been estimated that there are 11,200–14,800 metering and pressure regulating stations with inlet pressures greater than 300 psig in the United States (see section 3.1), and 34,600–56,700 stations with inlet pressures between 100 and 300 psig. Approximately 23%–25% of the stations with inlet pressures greater than 300 psig are contained within vaults, which is typical for stations located near urban or suburban areas. Therefore, it is likely that several thousand high-pressure city gate stations are located in close proximity to large U.S. urban areas where natural gas is transferred from transmission lines to distribution lines, and many of these may be candidates for hydrogen extraction.

Contents

Introduction	1
Benefits of Blending	3
Lifecycle Assessment – Literature Review by GTI and NaturalHy	3
Renewable Gas Credit Trading Considerations.....	3
Extent of the U.S. Natural Gas Pipeline Network	4
Pipeline Type, Capacity, Miles, Size, and Materials.....	4
Major U.S. Pipeline Corridors.....	8
Natural Gas Pipeline Capacity and Utilization.....	8
Impact on End-Use Systems	15
Safety	15
NaturalHy Safety Assessment	15
Greenhouse Gas Programme Safety Assessment (IEA).....	18
Gas Technology Institute Safety Assessment of Distribution Pipelines	18
Material Durability and Integrity Management	19
NaturalHy Studies Review of Durability	19
NaturalHy Studies Review of Integrity	19
Leakage	20
NaturalHy Pipeline Leakage Assessment.....	20
Greenhouse Gas Programme Pipeline Leakage Assessment.....	20
GTI Steel and Ductile Iron Pipe Leakage Assessment.....	20
GTI Estimate of Gas Loss in U.S.-Grade Plastic Distribution Pipelines.....	21
Downstream Extraction	21
NaturalHy Membrane Studies Review	21
Technologies for Extracting Dilute Hydrogen from a Pipeline.....	21
Cost Estimate of Hydrogen Extraction from a Distribution Natural Gas Pipeline.....	27
Summary and Recommendations	30
References	32
Appendix A: GTI Subcontract Report to NREL “GTI Review Studies of Hydrogen Use in Natural Gas Distribution Systems”	35

List of Figures

Figure 1. General order of stringency conditions on hydrogen blends for appliances, safety, and material durability (Florisson 2009).	2
Figure 2. Natural gas supply chain consisting of gathering lines, transmission lines, distribution mains, and distribution service lines.	4
Figure 3. Annual mileage of pipe for four natural gas pipeline types (PHMSA 2012).	5
Figure 4. Pipeline material as a percentage of miles for gathering lines, transmission lines, distribution mains, and distribution service lines (PHMSA 2012).	7
Figure 5. Pipeline material as a percentage of miles of all pipeline types (PHMSA 2012).	8
Figure 6. U.S. natural gas pipeline network in 2009 (EIA 2012).	9
Figure 7. U.S. natural gas pipeline compressor stations illustration (2008) (EIA 2012).	10
Figure 8. U.S. underground natural gas storage facilities (2007) (EIA 2012).	11
Figure 9. Major U.S. natural gas transportation corridors (2008).	12
Figure 10. Interstate natural gas supply dependency (2007) (EIA 2012).	13
Figure 11. Interregional natural gas transmission pipeline capacity (2008 data) (EIA 2012).	14
Figure 12. Risk to an individual per year as a function of distance from the pipeline.	17
Figure 13. Risk to an individual per year by adding hydrogen to the natural gas pipeline: UK data.	17
Figure 14. Simplified PSA arrangement.	22
Figure 15. Estimated cost of hydrogen extraction by PSA unit from 300 psi natural gas distribution pipeline (assumed hydrogen recovery factor is 80%).	29
Figure 16. Hydrogen extraction cost breakdown.	29
Figure 17. Breakdown of capital cost contribution to the hydrogen extraction cost.	30
Figure 18. Estimated cost of hydrogen extraction by PSA unit at the pressure-reduction facility (from 300 psi to 30 psi).	30

Introduction

Hydrogen can play an important role as an energy carrier in a sustainable, reliable, and cost-effective energy future. This report reviews key issues related to the concept of blending hydrogen into natural gas pipeline networks. Under appropriate conditions and at relatively low hydrogen concentrations, blending may require only minor modifications to the operation and maintenance of the pipeline network. The hydrogen blend component may be carried through to end-user systems, or the hydrogen could be extracted downstream and used in applications such as automotive or stationary fuel cells. In general, based on research to date, only minor issues arise with blends of less than 5%–15% hydrogen (by volume), depending on site-specific conditions and particular natural gas compositions. More significant issues must be addressed for higher blends in the range of 15%–50%, such as conversion of household appliances or an increase in compression capacity along distribution mains serving industrial users. Blends above 50% face more challenging issues across multiple areas, including pipeline materials, safety, and modifications required for end-use appliances or other uses.

Hydrogen blending may prove to be a viable means of increasing the output of renewable energy facilities, such as wind farms, by providing a hydrogen storage and delivery pathway across a broad range of geographic locations. Given the large geographic scope and scale of the existing natural gas infrastructure, even very low blend levels (less than 3%–5%) could absorb very large quantities of otherwise curtailed or uneconomical wind or solar power. Blending renewable hydrogen with natural gas can improve the carbon intensity and sustainability of the final natural gas product delivered to consumers. Though this pathway requires additional analysis and research, and may be limited by site-specific conditions, it appears to be viable in the near term.

Blending may also prove to be a viable means of delivering hydrogen produced in remote locations and extracting the hydrogen downstream near end-use applications, such as FCEVs or stationary fuel cells. Hydrogen pipeline delivery is considered a cost-effective way to move hydrogen from its production location to end users, but only at large volumes and long distances. Moreover, the cost to construct a large-scale, dedicated hydrogen pipeline system is very high, and completion could take decades. Alternative delivery pathways will be employed during the early market growth phase. Some early market pathways, such as tank trucks or onsite production, may endure alongside pipeline delivery in a mature hydrogen infrastructure. If hydrogen blending in natural gas with downstream extraction proves to be economically viable during the early market growth phase, it could prove to be viable in the long term as an additional mode of delivery.

This report reviews seven key and interrelated issues related to hydrogen blending:

1. Benefits of blending
2. Extent of the U.S. natural gas pipeline network
3. Impact on end-use systems
4. Safety
5. Material durability and integrity management
6. Leakage
7. Downstream extraction.

The benefits of hydrogen blending and the extent of the U.S. natural gas pipeline network provide context for the concept of blending and are reviewed in Sections 2 and 3. The next three issues limit

the blend fraction that might be found acceptable, in the general order of stringency indicated in Figure 1; actual blend levels that might be found acceptable will be very location and system specific and will depend on a number of factors (Florisson 2009). The impact on existing end-use systems limits the hydrogen blend factor the most and is discussed first (Section 4). Safety is the next most limiting condition (Section 5). Pipeline material durability imposes fewer limitations than end uses or safety but is still an important consideration, especially for high-pressure transmission lines (Section 6). The issue of leakage is addressed in Section 7, and Section 8 discussed methods of extracting hydrogen. A simple cost analysis suggests that extraction at pressure reduction stations is likely to prove more economical than extraction along transmission lines. Though these issues are interrelated, they are presented separately for the sake of clarifying explanation. Section 9 provides a summary and recommendations.

Summary of GTI Subcontract Report to NREL

The Gas Technology Institute (GTI) performed a literature review for NREL and assessed some aspects of blending hydrogen into the existing U.S. natural gas pipeline system. The full GTI report is included here as Appendix A. This review covers the major aspects of blending addressed by the European NaturalHy project (Florisson 2012).¹ GTI also included additional literature sources on material performance in hydrogen environments and provided a scientific basis for assessing the durability and integrity of the existing pipeline infrastructure and potential gas leakage under hydrogen service.

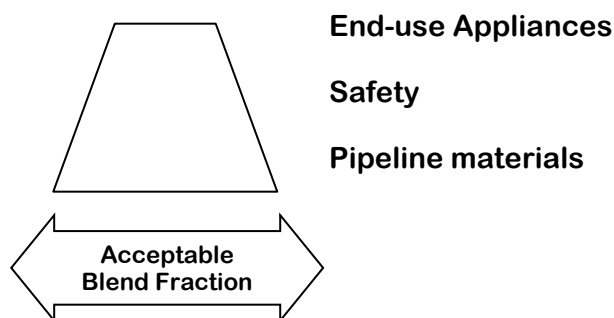

Figure 1. General order of stringency conditions on hydrogen blends for appliances, safety, and material durability (Florisson 2009).

¹ The goal of the NaturalHy Project is to determine the feasible conditions under which hydrogen produced from a centralized production site can be injected into high-pressure transmission pipelines and delivered to end users through distribution networks. The NaturalHy project, which was co-financed by the European Commission through the Sixth Framework Program for research, technology development and demonstration. spanned from 2004 to 2009, (<http://www.naturalhy.net/>).

Benefits of Blending

Lifecycle Assessment – Literature Review by GTI and NaturalHy

The potential benefits of adding hydrogen to natural gas have been addressed in the “NaturalHy Project-Work Package 1” through life cycle and socio-economic assessment. This study was led by Loughborough University (UK), and participants included COGEN Europe (Belgium), The Energy Research Centre (Netherlands), Instituto de Soldadura e Qualidade (ISQ) (Portugal), Planungsgruppe Energie und Technik GbR (Germany), SAVIKO Consultants Ltd. (Denmark), and Technische Universität Berlin (Germany). The details of this review can be found in Appendix A, Task 4.

In summary, the following are benefits of adding hydrogen to the natural gas network:

- Overall benefits: significant reduction of greenhouse gas emissions if hydrogen is produced from renewable sources.
- Hydrogen in automotive applications: potential benefits from reducing petroleum consumption and improving air quality by reducing sulfur dioxide, oxides of nitrogen, and particulate emissions.
- Greening natural gas: when a hydrogen/natural gas mixture is used in existing appliances for heat and electricity generation. This benefit is similar to increasing the mix of renewable generation on the electricity grid in that it does not require significant changes in end-use equipment.

A better understanding of the cost-benefit tradeoffs for blending in the U.S. natural gas pipeline system, as compared to the European assessment, would require significant additional analysis and investigation.

Renewable Gas Credit Trading Considerations

Renewable natural gas is a very desirable feedstock. In California alone, state incentives for power generation offer \$4,500/kW and \$2,500/kW for fuel cell systems running on biogas and natural gas, respectively (self-generation incentive program – SGIP). However, California does not require the biogas to be directly used in a fuel cell system, but instead allows credit trading. For example, a water treatment plant that generates methane can choose to clean the methane and inject it in the gas pipeline system, generating certificates for producing renewable natural gas. These certificates can, in turn, be sold to a geographically remote entity that can apply the credits to classifying fossil natural gas as renewable. This entity can then use the gas in a fuel cell and claim credits as if the fuel cell were operating on renewable gas. Renewable methane in such trading is commonly valued at \$12–\$14/MMBtu (GSE 2011). For example, renewable gas can be purchased by this means from Pacific Gas & Electric. A similar credit trading system is conceivable for renewable hydrogen blended into the natural gas system.

Extent of the U.S. Natural Gas Pipeline Network

This section reviews general characteristics of the U.S. natural gas pipeline network to provide context for the concept of blending hydrogen into natural gas pipelines. Additional analysis would be needed to draw more concrete and detailed conclusions about the technical and economic potential for hydrogen blending with respect to the large amount of information available on pipeline system materials, performance, operation, and regional markets. Advantages of the existing natural gas pipeline network include the following:

- Broad geographic extent
- Interconnectivity
- High capacity
- Well-developed maintenance and control structure
- Well-established safety procedures
- Well-established grid management
- Well-established operational strategies
- Broad public acceptance.

Pipeline Type, Capacity, Miles, Size, and Materials

Four general types of transmission lines are indicated in the supply chain schematic in Figure 2. Gathering lines bring natural gas from various sources to processing plants, typically high-volume and long-distance transmission lines deliver gas to the city gate, and two types of distribution lines—mains and service lines—deliver it to local consumers. Underground storage facilities, typically depleted natural gas caverns or salt domes, and large industrial consumers are connected directly to transmission lines. In terms of supply capacity, the U.S. transmission line system is supplemented by natural gas storage capacity to meet peak demand during the winter heating season, and the distribution pipeline system is sized for this peak demand (EIA 2012).

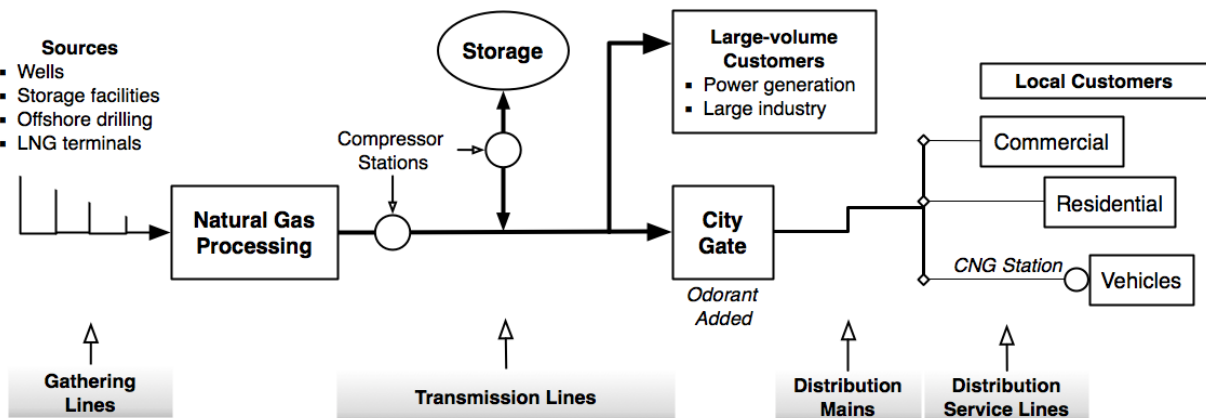

Figure 2. Natural gas supply chain consisting of gathering lines, transmission lines, distribution mains, and distribution service lines.

The annual mileage for each of these pipeline types is shown in Figure 3, with gathering lines and transmission lines changing only slightly and both types of distribution lines experiencing relatively steady growth since 1980. For 2011, the U.S. Department of Transportation reports 1.23 million miles of distribution mains and 0.88 million miles of distribution services lines. In 2011, there were 19,662 and 304,087 miles of gathering and transmission lines, respectively (PHMSA 2012). The network also includes 1,400 compressor stations and 400 underground natural gas storage facilities, most of which are depleted natural gas fields, oil fields, aquifers, and salt caverns (EIA 2012). These elements are indicated in the maps shown in Figures 6, 7, and 8. In 2010, natural gas provided 25% of all energy consumed in the United States (EIA 2011). This extensive infrastructure is a critical component of the U.S. energy system, comparable in scale to electricity and petroleum-based liquid fuels.

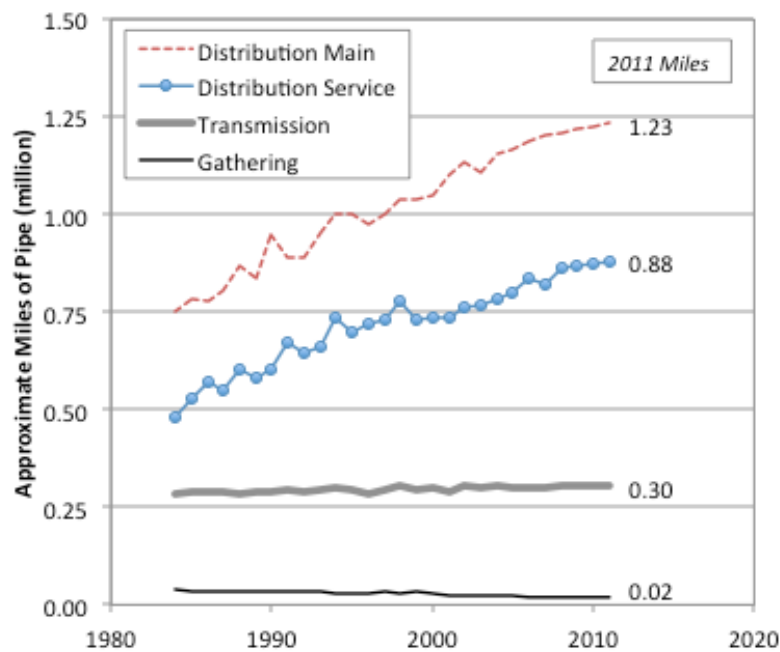

Figure 3. Annual mileage of pipe for four natural gas pipeline types (PHMSA 2012).

City gate stations with metering and pressure regulating equipment are relevant to the concept of blending hydrogen into natural gas pipelines. These stations are located where high-pressure transmission lines transfer gas to distribution systems (also called transmission-to-distribution custody transfer stations) and are therefore candidates for downstream hydrogen extraction. A study conducted by Radian International LLC for the U.S. Environmental Protection Agency and the Gas Research Institute estimated the number of metering and pressure regulating stations, as well as the number of stations with only pressure regulating equipment, in the United States in 1992 based upon data collected from eleven natural gas distribution companies (Campbell and Stapper 1996). The stations were categorized into four types according to the inlet pressure (psig): >300, 100–300, 40–100, and <40. Gas pressures in the distribution lines were not specified, but it was noted that stations with inlet pressures less than 300 psig were more typical of stations located downstream from gate stations. This study estimated the total number of U.S. stations using a ratio of the number of stations of each type to the total miles of main distribution lines. Applying these same ratios to the total number of main distribution miles in 2011 results in an estimate of 14,800 stations with inlet pressures greater than 300 psig, and 56,700 stations with inlet pressures between 100 and 300 psig. However, the 2010 Greenhouse Gas Inventory (EPA 2012) estimates the number of stations based upon the ratio of total

gas consumption in 2010 and 1992, rather than the station per mile ratios. This approach (Weitz 2012) provides an estimate of 11,200 and 34,600 stations at >300 psig and 100–300 psig, respectively. These estimates may be considered a high and low range on the total number of stations within these pressure inlet categories. Stations with lower inlet pressures, less than 100 psig, are more numerous, ranging from 102,000 to 134,300 stations based upon these two estimation approaches.

Nearly 100% of U.S. transmission pipelines are steel with diameters of 4–48 in. They typically operate at pressures of 600–1,200 psig (42–84 bar) and in some cases up to 2,000 psig (139 bar).

Approximately 96% of all onshore and offshore transmission pipelines are steel, wrapped/coated and cathodically protected against corrosion. Details about transmission pipelines can be found in Appendix A. The major U.S. natural gas transportation routes include 11 distinct corridors (Figure 9). The volume of gas delivered is proportional to the width of the routes. Five of them originate in the Southwest (1–5), four deliver natural gas to the United States from Canada (6–9), and the remaining two extend from the Rocky Mountain area (10–11).

Material use in pipelines is indicated by pipeline type in Figure 4. Steel and polyethylene (PE) are the dominant materials (47% and 48%, respectively) in the natural gas distribution system. Main distribution pipes are typically 1.5–8 in. wide and made of either PE (48%) or steel (47%). Distribution service line sizes are typically 0.5–2 in. wide and made of either PE (63%) or steel (33%). Other materials include cast iron and various plastics (see Appendix A). The fraction of miles for all U.S. pipelines (gathering, transmission, and distribution) by material type is indicated in Figure 5.

Distribution pipeline pressures are 0.25–60 psig (1.03–5.15 bar) and sometimes up to 100 psig (8 bar). A few distribution pipelines operate at pressures as high as 400 psig (29 bar). Distribution facilities are primarily located in populated areas. Distribution lines do not follow class locations, but most lines fall into Class 3 and Class 4 locations under transmission class location definitions.² Distribution piping is frequently located in congested urban areas, typically under paved streets, highways, and other public right-of-ways or utility easements. Additional details about the U.S. natural gas distribution pipelines can be found in Appendix A.

² The following are class location definitions from the Code of Federal Regulations (GPO 2011). A “class location unit” is an onshore area that extends 220 yards (200 meters) on either side of the centerline of any continuous 1-mile (1.6 kilometers) length of pipeline. A Class 1 location is: (i) An offshore area; or (ii) Any class location unit that has 10 or fewer buildings intended for human occupancy. A Class 2 location is any class location unit that has more than 10 but fewer than 46 buildings intended for human occupancy. A Class 3 location is: (i) Any class location unit that has 46 or more buildings intended for human occupancy; or (ii) An area where the pipeline lies within 100 yards (91 meters) of either a building or a small, well-defined outside area (such as a playground, recreation area, outdoor theater, or other place of public assembly) that is occupied by 20 or more persons on at least 5 days a week for 10 weeks in any 12-month period. (The days and weeks need not be consecutive.) A Class 4 location is any class location unit where buildings with four or more stories above ground are prevalent.

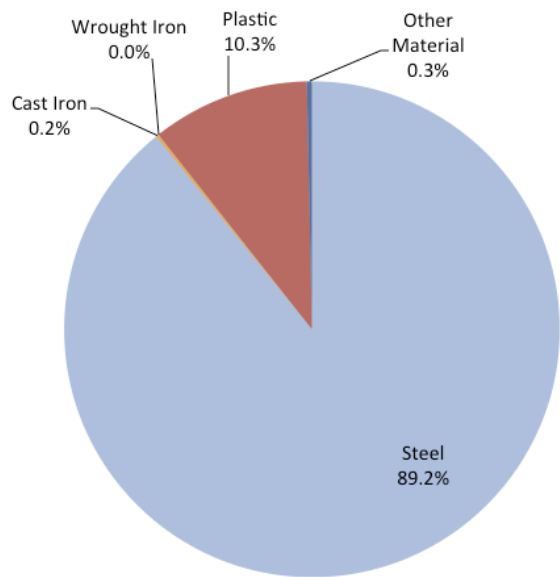

(a) Gathering lines

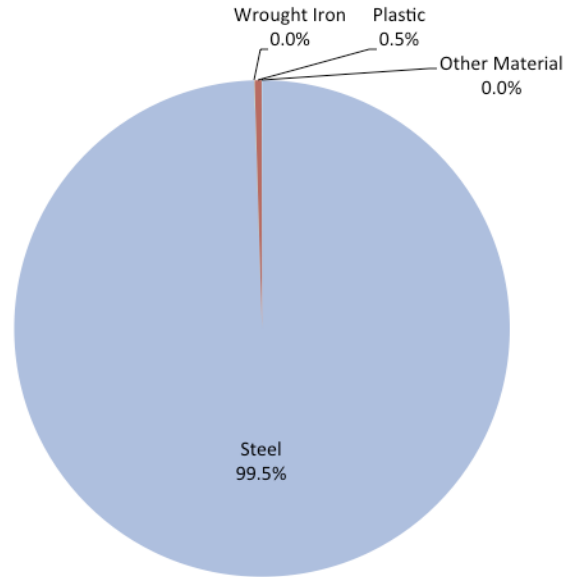

(b) Transmission lines

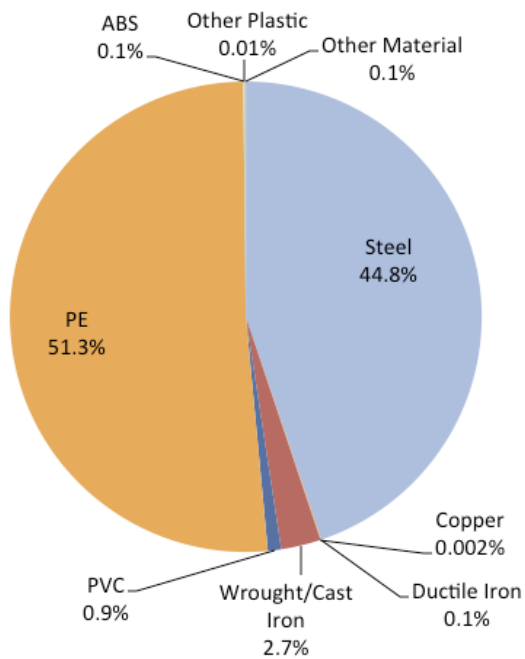

(c) Distribution mains

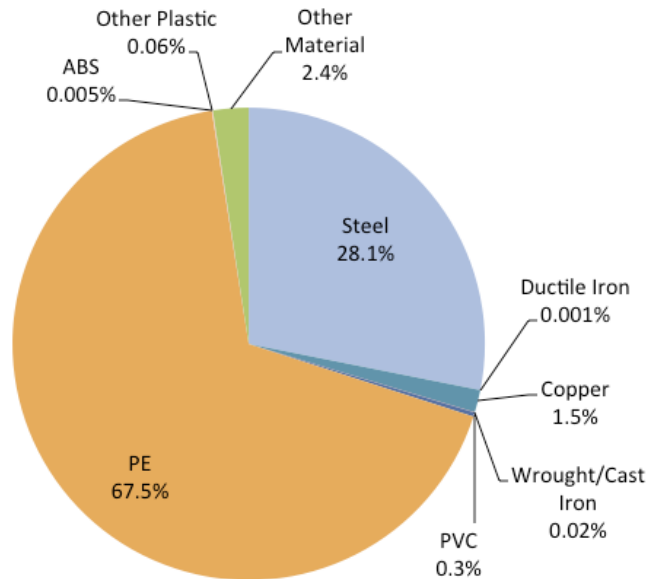

(d) Distribution service lines

Figure 4. Pipeline material as a percentage of miles for gathering lines, transmission lines, distribution mains, and distribution service lines (PHMSA 2012).

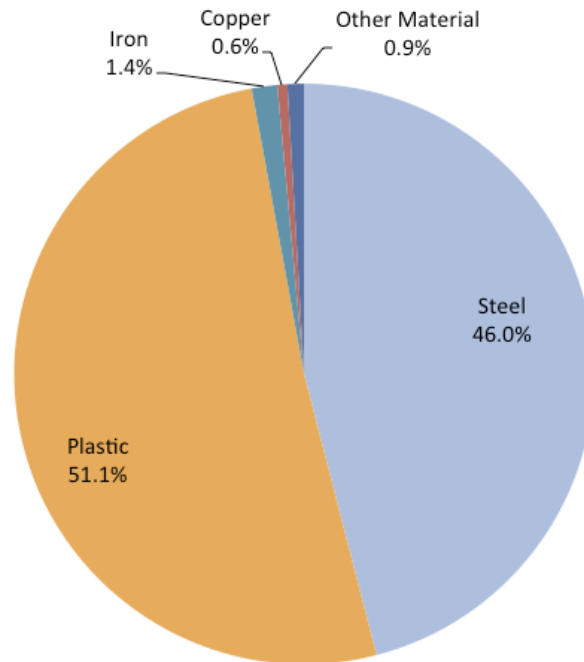

Figure 5. Pipeline material as a percentage of miles of all pipeline types (PHMSA 2012).

Major U.S. Pipeline Corridors

The interstate pipeline grid consists of wide-diameter (20–42 in.), high-capacity pipelines. In 2007, more than 36 trillion ft³ of natural gas were transported by the interstate pipeline system. Figure 10 shows interstate natural gas supply dependency, particularly designating states that are more than 85% dependent on the interstate pipeline network for their supply. Intrastate natural gas pipelines operate within state borders and link natural gas producers to local markets and to the interstate grid. Intrastate pipelines constitute about 29% of the total miles. Texas and California have the largest intrastate pipeline systems in the nation. Intrastate and interstate pipelines are color coded in Figure 6.

Natural Gas Pipeline Capacity and Utilization

Even though natural gas companies prefer to operate their systems as close to full capacity as possible, the average utilization rate seldom reaches 100% (EIA 2012). Figure 11 shows the interregional natural gas transmission pipeline capacity (2008 data). Utilization rates below 100% do not necessarily entail additional capacity availability, as some companies serve seasonal markets. Exceeding 100% capacity, while remaining within safety limits, is a technique used to temporarily raise pipeline throughput. This is achieved by secondary compression, line packing, or both. Average daily utilization rates also can be increased by integrating storage capacity into natural gas pipeline networks.

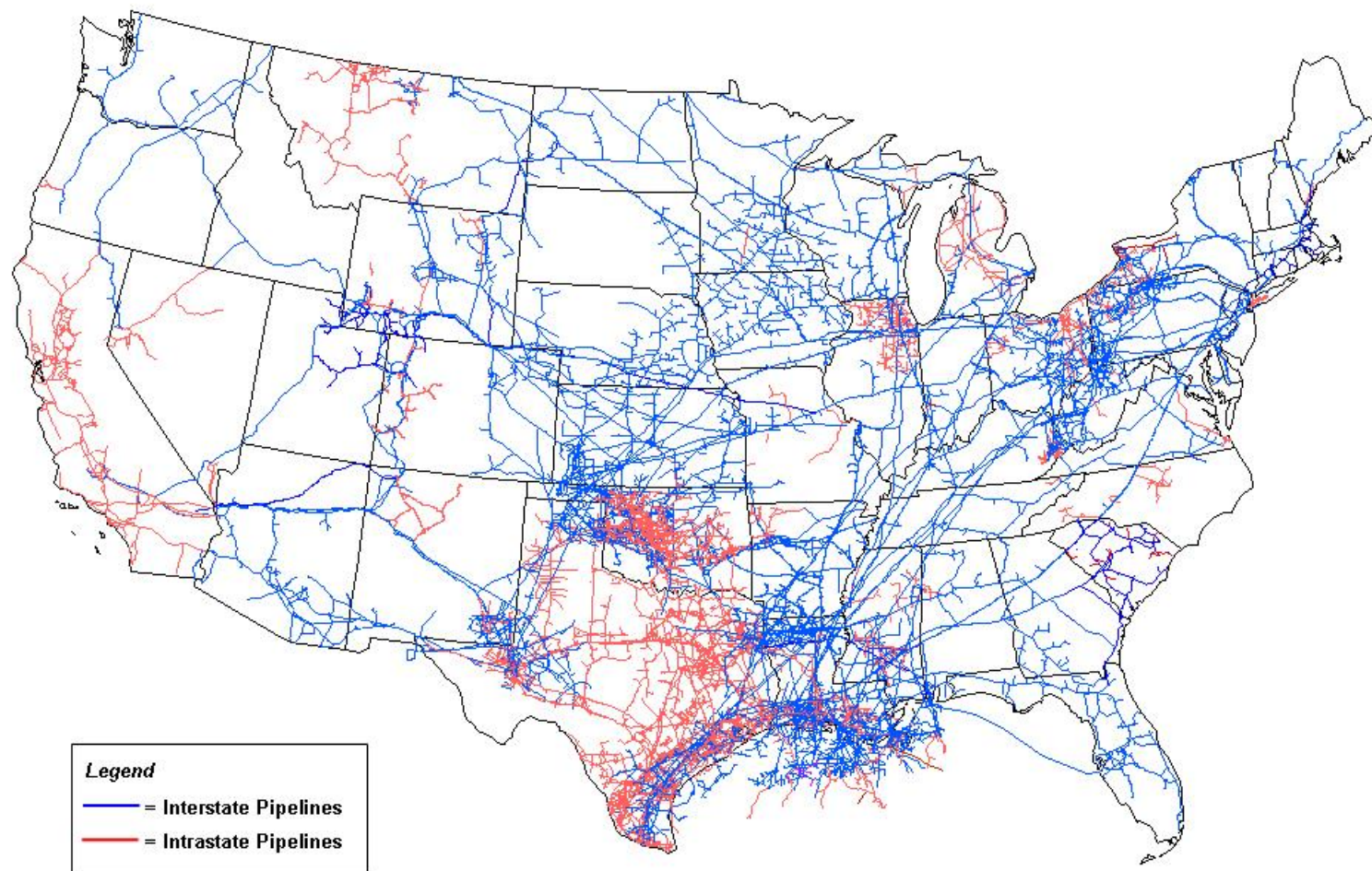

Figure 6. U.S. natural gas pipeline network in 2009 (EIA 2012).

From the U.S. Energy Information Administration (EIA), Office of Oil and Gas Division, Gas Transportation Information System.
The EIA has determined that this informational map does not raise security concerns.

U.S. Natural Gas Pipeline Compressor Stations Illustration, 2008

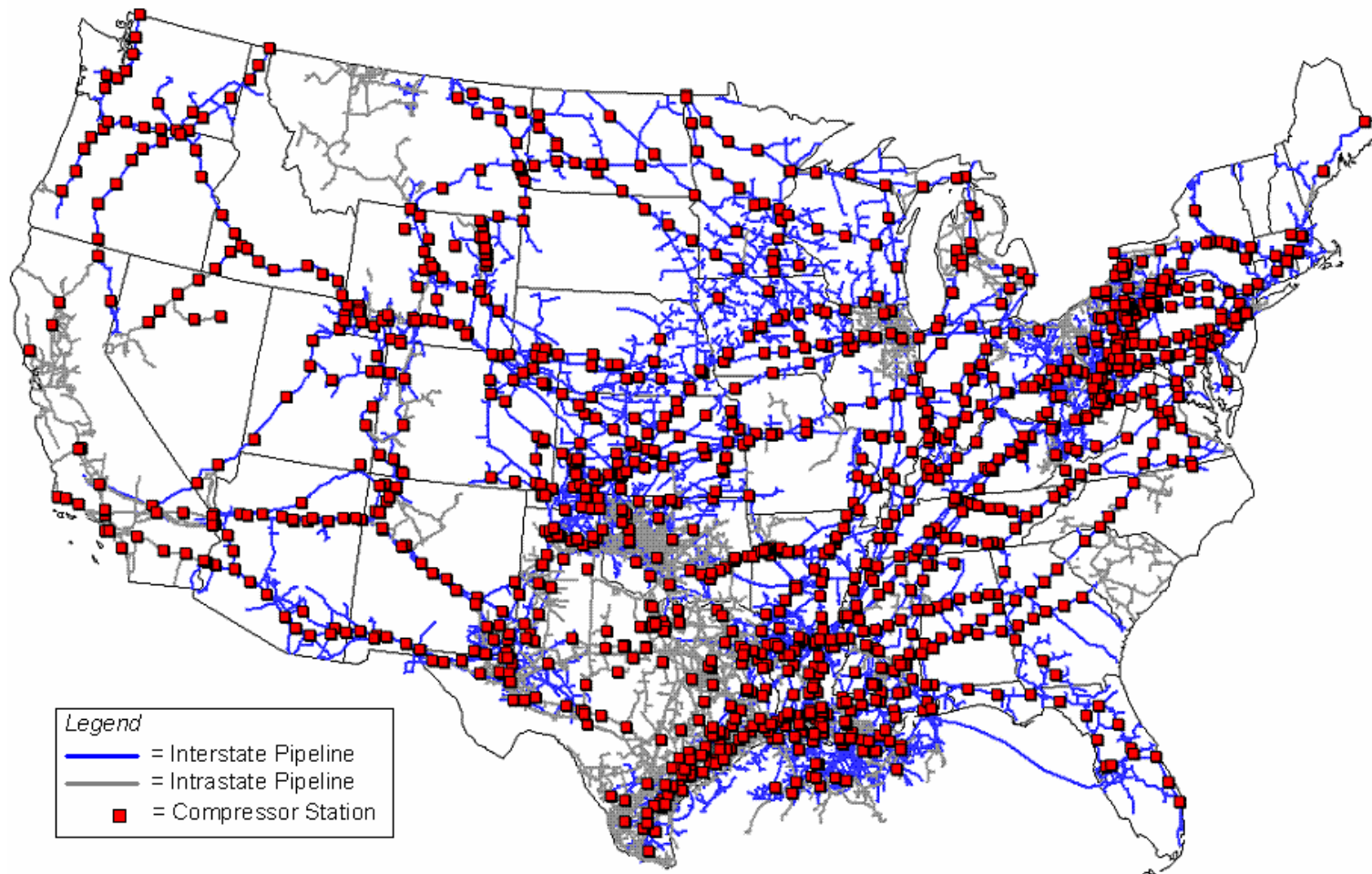
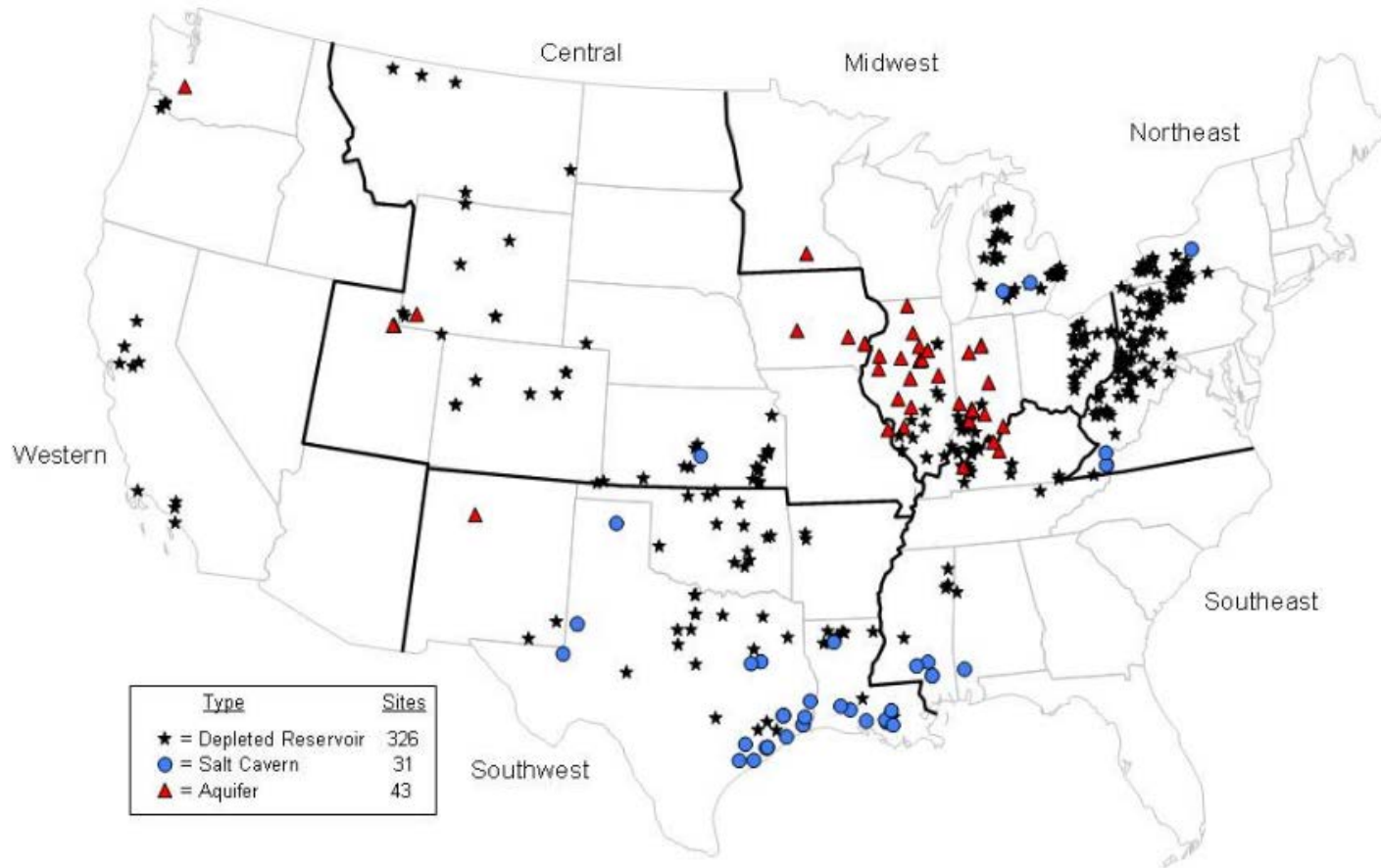

Figure 7. U.S. natural gas pipeline compressor stations illustration (2008) (EIA 2012).

U.S. Underground Natural Gas Storage Facilities, Close of 2007



Source: Energy Information Administration, Office of Oil & Gas, Natural Gas Division Gas, Gas Transportation Information System, December 2008.

Figure 8. U.S. underground natural gas storage facilities (2007) (EIA 2012).

Major U.S. Natural Gas Transportation Corridors, 2008

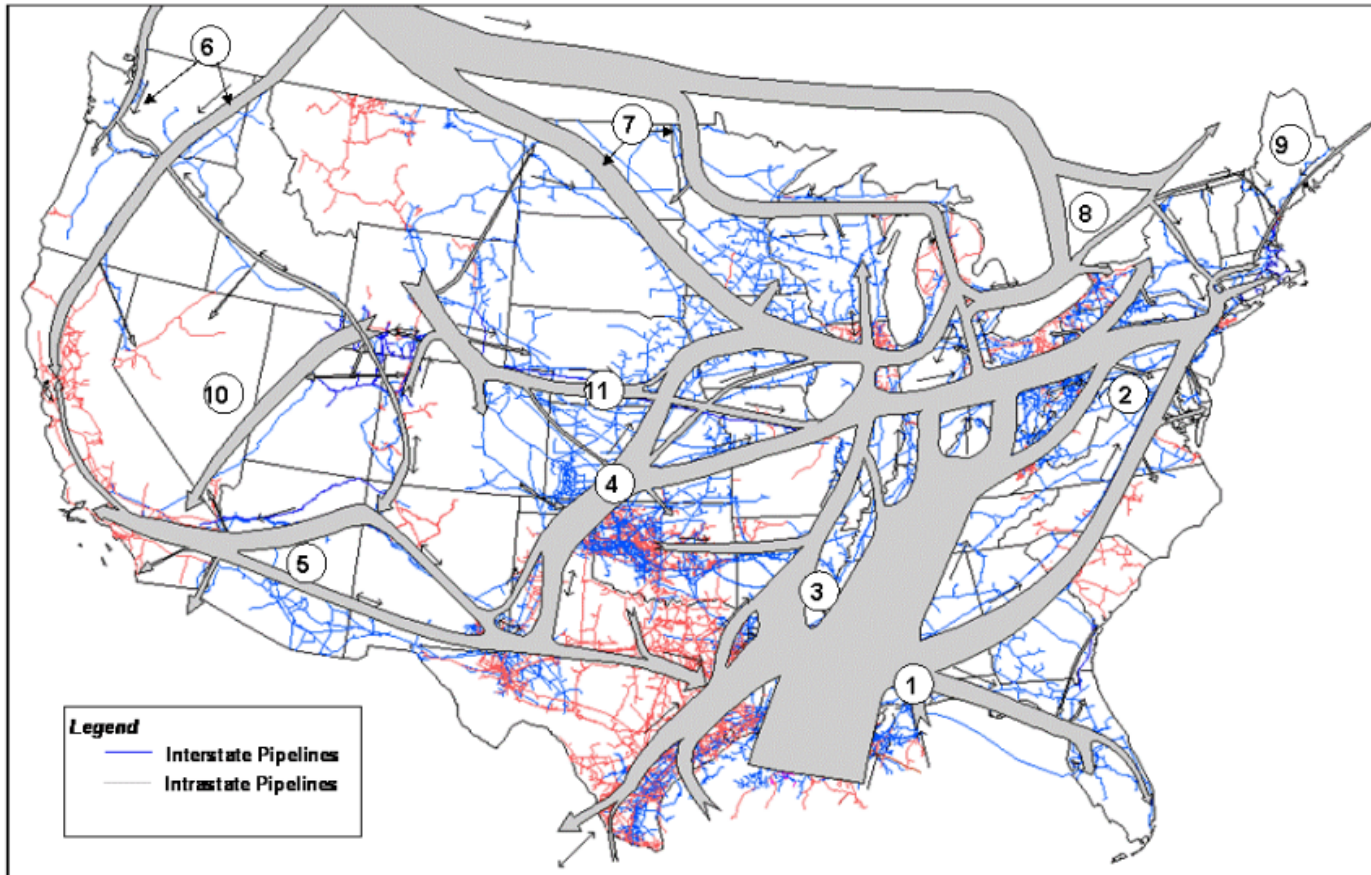

Source: Energy Information Administration, Office of Oil and Gas, Natural Gas Division, GasTran Gas Transportation Information System.

Figure 9. Major U.S. natural gas transportation corridors (2008).

The volume of gas delivered is proportional to the width of the routes. Five routes originate in the Southwest (1–5), four deliver natural gas to the United States from Canada (6–9), and the remaining two extend from the Rocky Mountain area (10–11). Source: EIA 2012.

Interstate Natural Gas Supply Dependency, 2007

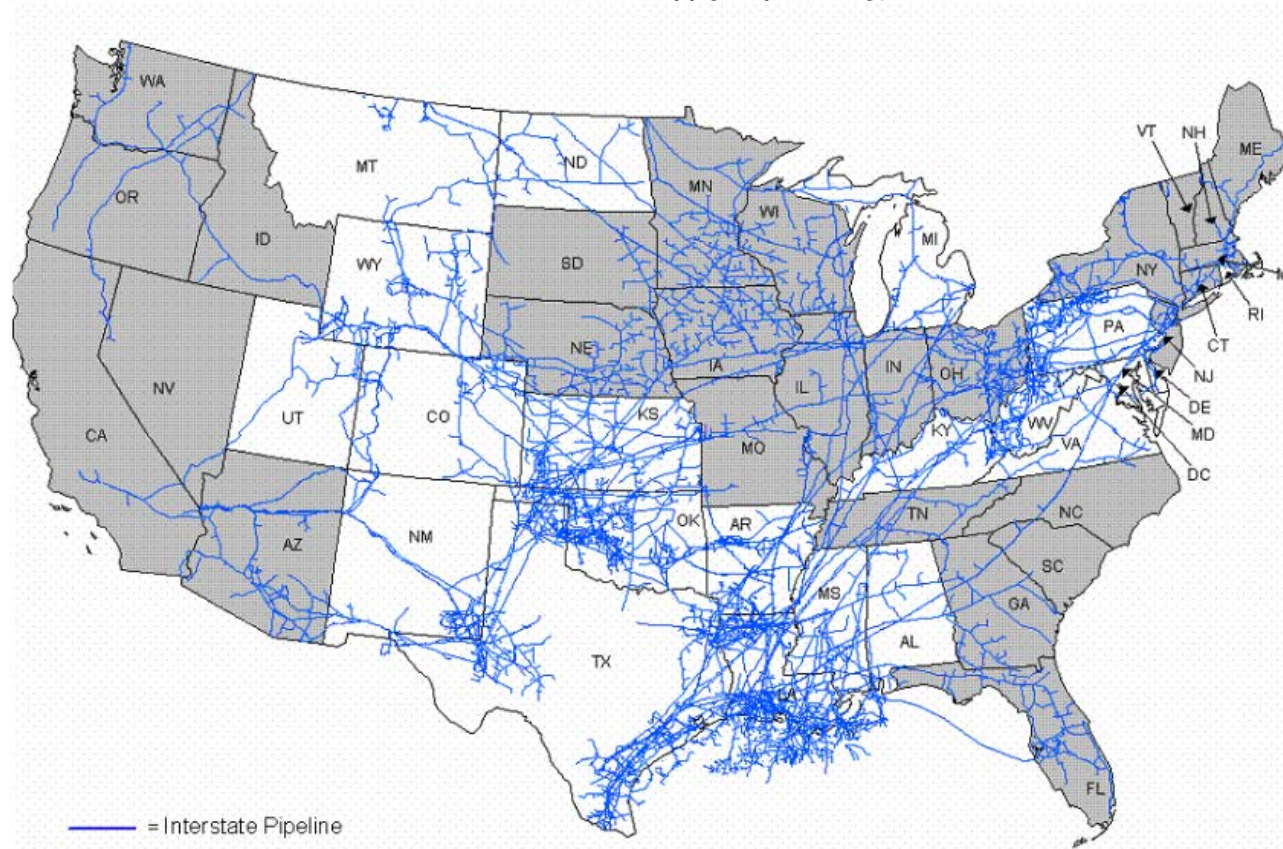

Figure 10. Interstate natural gas supply dependency (2007) (EIA 2012).

States that rely on the interstate delivery system for more than 85% of their natural gas consumption are shown in gray. Note: A state's relative dependence on the interstate natural gas pipeline network for its supplies was determined by the ratio of natural gas consumed within the state in 2007 to the amount of natural gas produced within the state. A state with no natural gas production was 100% dependent on the interstate natural gas pipeline network for its supplies. Source: Energy Information Administration, Form EIA176 "Annual Report of Natural Gas and Supplemental Gas Supply and Disposition" (EIA 2012).

Interregional Natural Gas Transmission Pipeline Capacity, Close of 2008
(Million cubic feet per day)

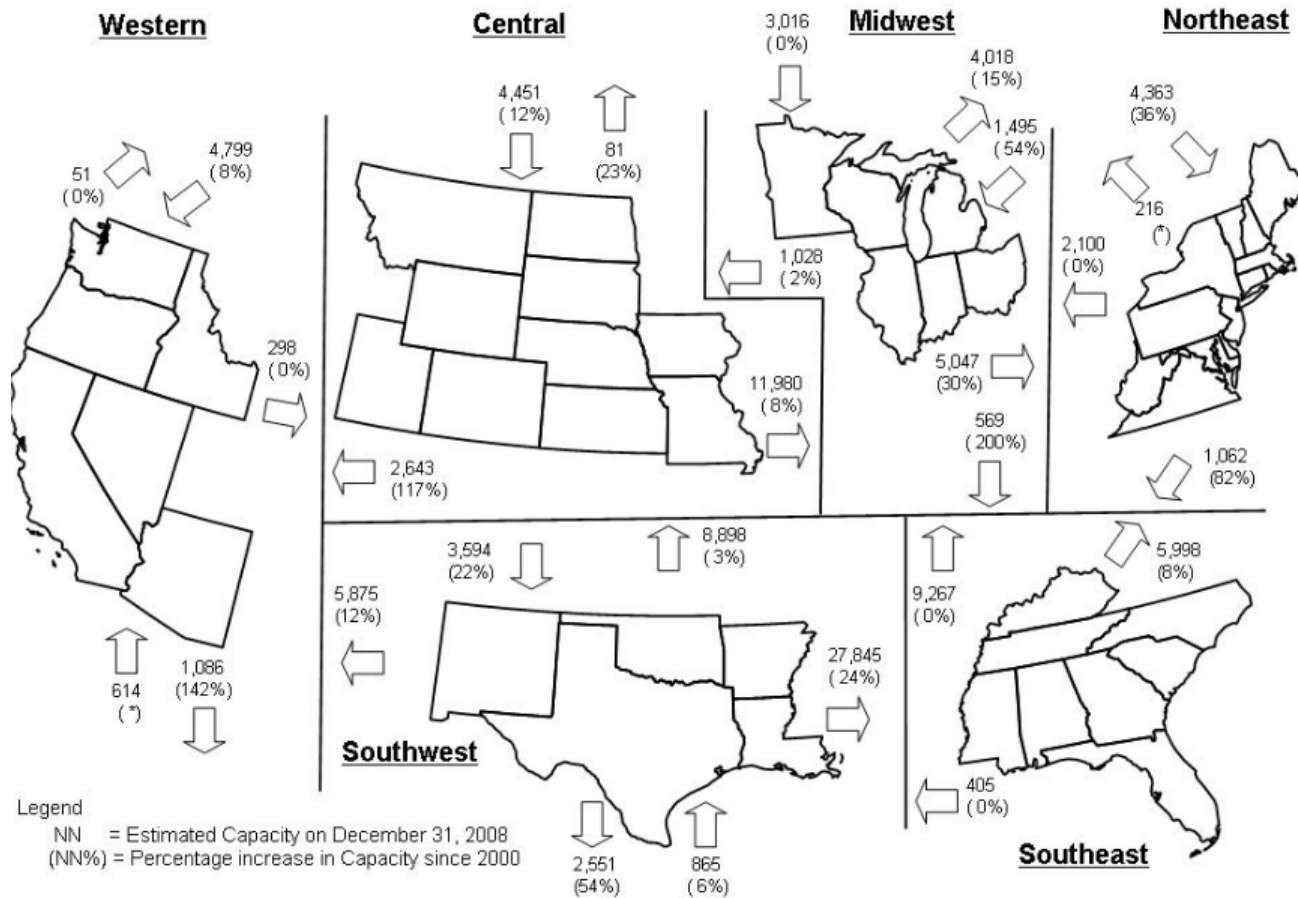

Figure 11. Interregional natural gas transmission pipeline capacity (2008 data) (EIA 2012).

Impact on End-Use Systems

Adaptation of end-use systems is required at higher hydrogen blend levels. NREL reviewed NaturalHy studies on the impacts for the end user that might be caused by adding hydrogen to natural gas pipelines (De Vries 2009). The study included an assessment of maximal hydrogen concentrations that required no or minor appliance adjustments. The study concluded that hydrogen concentrations up to 28% may safely be used with properly serviced existing domestic appliances. Long-term (more than 15 years from now) material compatibility of domestic appliances with hydrogen and natural gas mixtures is uncertain. For poorly adjusted appliances, no hydrogen blends would be acceptable (Florisson 2010). The natural gas composition in a given pipeline is an important consideration (Zachariah-Wolff et al. 2007).

Haines et al. (2003) estimate the cost of upgrades—in the United Kingdom, the Netherlands, and France—with respect to sensor modifications required for a 3% blend (\$430,000 to \$470,000 for each country) and then the cost of modifying engine controls (\$5.6 million in the United Kingdom, \$30 million in the Netherlands, and no cost in France), medium-pressure transmission lines (\$500–\$850 million for each country), and domestic appliances (\$170–\$470 million for each country) for introduction of a 12% blend.

NaturalHy recommended that the consequences of mixing hydrogen with natural gas for industrial combustion applications be considered case by case. Several restrictions might apply for stationary natural gas engines and modern gas turbines. The preferable operating regime of stationary gas engines does not favor hydrogen concentration variations. These devices will need to be modified or adjusted based on manufacturer specifications. Modern gas turbines have strict fuel specifications. Operation outside of these specifications will require modification or readjustment of control systems with manufacturer permission. Also, unexpected hydrogen concentration variations are unacceptable for gas turbines (Florisson 2010).

Safety

The safety review included publications of the NaturalHy Project (Florisson 2010) and the Greenhouse Gas R&D Programme (Haines et al. 2003) sponsored by the International Energy Agency (IEA). Also, GTI performed a quantitative risk assessment of conveying hydrogen via the current U.S. natural gas distribution system. The details of the review and risk assessment can be found in Appendix A, Task 4.2.

NaturalHy Safety Assessment

The potential risks of transporting hydrogen using the existing natural gas pipeline network have been investigated by “NaturalHy Project in Work Package 2.” This work was led by Loughborough University (UK); Leeds University (UK); Commissariat à l’Energie Atomique (France); Shell Hydrogen; Health and Safety Executive (UK); and National Grid (UK). The NaturalHy Project assessed (through modeling and experimentation) three risks of adding hydrogen to natural gas, which are summarized in the following sections (Lowesmith 2009):

- Gas buildup
- Explosions in enclosures
- Risk from transmission pipelines.

Gas Buildup

The NaturalHy study examined gas buildup behavior in two experimental releases, one in a smaller household room and another in a larger room more typical of a commercial or industrial building. It was found that gas buildup behavior of blends was similar to that of pure natural gas. No separation of hydrogen from the mixture was observed. Increased flow rate resulted in higher gas concentrations, but to a lesser extent than anticipated due to buoyancy-driven ventilation generated by the release. In general, the steady-state concentration following a release is only slightly higher for blends of up to 50% hydrogen, but concentration increases become more significant for hydrogen blends greater than 70% (Florisson 2010; Lowesmith 2009).

Explosions in Enclosures

Compared with explosions of pure natural gas in confined areas, the relative increase in the severity of confined vented explosions was modest for blends with less than 20% hydrogen. A more significant increase in overpressure, and therefore risk or damage, was observed for blends with more than 50% hydrogen. Vapor cloud explosion overpressure can be significantly reduced for higher hydrogen concentrations if ventilation is used or if the structural congestion causing confinement is reduced (Florisson 2010; Lowesmith 2009).

Risk from Transmission Pipelines

Risk here is determined using the following general equation:

$$\text{Risk} = \text{Frequency of Pipeline Failure} \times \text{Probability of Ignition} \times \text{Consequences of the Fire}$$

This risk can be estimated on an individual or societal basis. When defined as an individual risk, the result is the likelihood of a person becoming a fatality in a year. NaturalHy used a risk evaluation model to determine these values. For transmission pipelines, the risk factor was dominated by the rupture of the pipeline (Florisson 2009, p. 24).

Compared to natural gas transmission pipeline explosions, there is a consistent tendency for the severity of the risk with hydrogen mixtures to shift spatially, increasing closer to the point of explosion and decreasing further from the point of explosion. This shift in the spatial extent of risk is increased for higher concentrations of hydrogen, as shown in Figure 12. For the large, high-pressure pipeline represented by results in Figure 12 (914 mm and 70 bar [1,000 psig]), the magnitude of risk to an individual per year declines for hydrogen blends at a distance of 265–400 m and increases closer to the pipeline (0–275 m). The risk associated with explosion of a natural gas pipeline drops to zero at just over 400 m from the pipeline (Figure 12). However, adding 25% hydrogen decreases this distance by about 25 m while slightly increasing risk closer to the pipeline. The important causal factor here is the more rapid dispersion of hydrogen mixtures, which results in lower concentrations at shorter distances and therefore reduced risk at the far edge of the hazard distance. For 50% and 75% mixtures, the hazardous distance is reduced by about 75 m and 100 m, respectively, and the increase in risk closer to the pipeline is more significant. Given this generic risk result for a transmission pipeline, site-specific risks would vary depending on the population density and distribution near the pipeline. As a reference, the area contained within a radius of 280 meters is roughly equal to the area contained between the

radii of 280 and 400 meters, which is where the probability of risk is reduced for higher hydrogen blends.

This shift in the spatial extent of risk has been examined for multiple pipeline sizes (Figure 13). The figure compares the risk of explosion for various pipeline diameters with 100% natural gas and a blend of 75% natural gas and 25% hydrogen. The 508-mm pipeline is apparently at a lower pressure than the other pipelines and therefore follows a different trend (Lowesmith 2009). The smaller-diameter pipelines have shorter hazardous distances, and the addition of 25% hydrogen reduces the hazardous distance while slightly increasing risk near the pipeline. This shift is quite small for a 25% blend. As mentioned above, for higher blends and specific pipeline segments, it would become more important to consider population density across the hazard distance to properly interpret the significance of this spatial shift in risk.

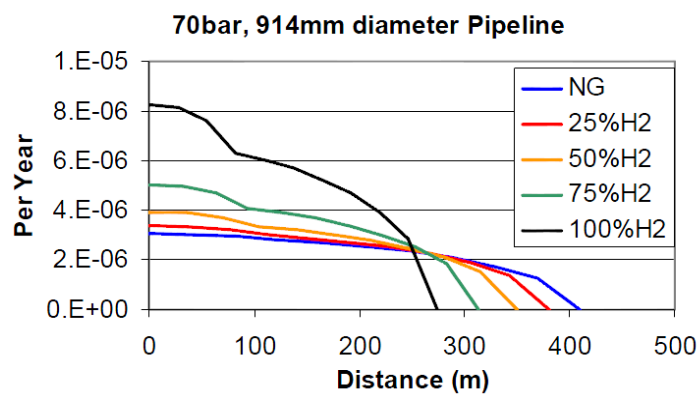

Figure 12. Risk to an individual per year as a function of distance from the pipeline.
Risk shown is individual risk: the likelihood of a person becoming a fatality in a given year. Source: Lowesmith 2009. Displayed with permission.

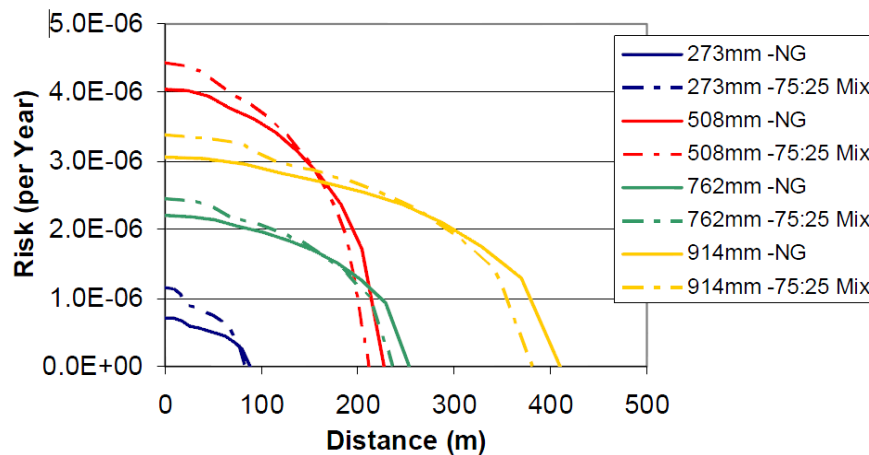

Figure 13. Risk to an individual per year by adding hydrogen to the natural gas pipeline: UK data.
Risk shown is individual risk: the likelihood of a person becoming a fatality in a given year. Source: Lowesmith 2009. Displayed with permission.

Greenhouse Gas Programme Safety Assessment (IEA)

A review of the IEA report on hydrogen blending is provided by Haines et al. (2003). The study focuses on a blend of 25% hydrogen in natural gas and provides a general assessment of hazards associated with a matrix of six causes and six consequences. Notably, compared to the use of natural gas without a hydrogen component, hazards are increased in cases of fire resulting from unburned gas in the air and in the case of burns resulting from the use of gas and open fire in a device or heating appliance. Hazardous phenomena are reduced by blends in four other cases: explosion resulting from unburned gas in air, suffocation due to unburned gas in air, suffocation due to flue gas system (malfunction), and poisoning due to heated media (Haines et al. 2003). Ten other hazards are identified as being unchanged in terms of risk when adding hydrogen to natural gas. Note that the general claim of a reduction in risk posed by explosion due to unburned gas in air is somewhat at odds with the more specific claim of slightly increased overpressure resulting from confined vented explosions with 20% hydrogen blends reported by Lowesmith et al. (2011). This emphasizes the condition-specific nature of risk assessments and the limited degree to which general statements can be used to simplify a complex topic.

Gas Technology Institute Safety Assessment of Distribution Pipelines

Distribution pipeline incidents typically result in a leak instead of a rupture because of their relatively low operating pressures (see Appendix A). According to 2007 data from the U.S. Department of Transportation (PHMSA 13), the following are eight major distribution pipeline failure modes caused by leakage:

- Corrosion
- Material defect
- Natural force
- Excavation damage
- Other outside force
- Equipment malfunction
- Operation
- Other.

GTI assessed the risk aggravation of adding hydrogen at various levels for these failure modes for distribution mains and service pipes. Detailed results are provided in Tables 13 and 14 in Appendix A. In summary, the GTI analysis suggests that adding hydrogen to the natural gas pipeline network increases risk posed by leakage. However, this increase is small for service lines at concentrations of less than 20% hydrogen, and the increase is moderate for distribution mains at less than 50% hydrogen (Appendix A). Again, many different factors influence risk estimates, and actual risks can vary widely from location to location.

Material Durability and Integrity Management

This section briefly notes reviews of pipeline material durability and integrity with the use of hydrogen and natural gas blends. Appendix A provides additional detail. Durability refers to the potential physical and chemical impact of hydrogen on pipeline materials, especially embrittlement of steel, and integrity management refers to the various practices conducted by pipeline operators to inspect, maintain and assess pipeline systems. These topics are discussed in the Executive Summary, and the sections below notes previously conducted reviews.

NaturalHy Studies Review of Durability

Durability was studied in “NaturalHy Project-Work Package 3.” This investigation was led by GDF SUEZ (France), with participation by Commissariat à l’Energie Atomique (France), CMI, CSM, DBI Gas (Germany), DEPA, Ecole Nationale des Ingénieurs de Metz (France), Gasunie Technology & Assessts (Netherlands), Institut Français du Pétrole, Istanbul Gas Distribution Co. Inc. (Turkey), Instituto de Soldadura e Qualidade (Portugal), StatoilHydro (Norway), TNO Science and Technology (Netherlands), TOTAL (France), and Turkish Scientific and Technical Research Council. The details of this review can be found in Appendix A (Task 4.4).

In addition, the GTI report includes literature sources related to the effect of hydrogen mixtures on pipeline materials and equipment. The details of this review can be found in Appendix A (Task 4.4).

NaturalHy Studies Review of Integrity

The need to upgrade the current IMP for transporting hydrogen and natural gas mixtures was investigated in “NaturalHy Project-Work Package 4.” The aim of this project was to provide a specification for an Integrity Management Tool (IMT) that allows the operator to modify the existing IMP for hydrogen service. The cost of the new IMP was also evaluated in this study. This work was led by DBI Gas (Germany), with participation by TNO Science & Industry (Netherlands), Computational Mechanics BEASY (UK), GDF SUEZ (France), PII Ltd. (UK), Istanbul Gas Distribution Co. Inc. (IGDAS), N.V. Nederlandse Gasunie (Netherlands), Instituto de Soldadura e Qualidade (Portugal), Turkish Scientific and Technical Research Council, StatoilHydro (Norway), and TOTAL (France). The details of this review can be found in Appendix A (Task 4.5). Florisson et al. (2010) outline general conclusions of detailed studies of both durability and integrity issues, and they estimate that modifications to existing integrity management practices may incur an additional 10% cost increase due to hydrogen blends.

In the United States, the Pipeline and Hazardous Materials Safety Administration (PHMSA) has implemented integrity management requirements for hazardous liquid and gas transmission pipelines, but no similar requirements currently exist for non-hazardous gas distribution pipelines. In 2009, PHMSA published the final rule effective on February 12, 2010, to establish integrity management requirements for gas distribution pipeline systems. Operators are given until August 2, 2011, to write and implement the integrity program for distribution pipeline systems.

GTI reviewed the natural gas distribution systems and the 14 potential threats to the distribution systems identified by the American Gas Foundation through a survey of utility operators. GTI

reevaluated each threat for the conditions under which the systems transport hydrogen and natural gas mixtures. The details of this study can be found in Appendix A (Task 4.5).

Leakage

Hydrogen is a much smaller molecule than methane, so its leakage rate through pipe walls and joints may be greater; it also causes economic and safety concerns because of the total gas loss. Leakage assessments include publications from the NaturalHy Project (Florisson 2012), which focuses on the permeability of plastic pipe materials, including PE and PVC; a report from the IEA Greenhouse Gas R&D Programme (Haines et al. 2003); and other relevant information for gas leakage in the natural gas distribution pipeline under hydrogen services. The details of this review can be found in Appendix A. The following sections summarize the findings.

NaturalHy Pipeline Leakage Assessment

The NaturalHy Project investigated permeation gas loss from plastic pipes in Work Package 3. This work was performed by Gaz de France.

PE80 Pipeline (10% Hydrogen)

The pressures tested were 58, 116, and 174 psig (5, 9, and 13 bar). Table 14 of Appendix A shows the permeation coefficients and gas losses for hydrogen and methane in a mixture of 90% methane and 10% hydrogen. The following are the findings:

- The hydrogen permeation coefficient is four or five times higher than that of methane.
- The permeation rate of methane and hydrogen increases with pressure.
- The aging of pipelines has no apparent significant effect on permeation coefficients.

Polyethylene Disk Samples (20% Hydrogen)

A 20% hydrogen mixture at 58 psig (5 bar) was investigated for leakage (Haines et al. 2003). The leakage rates for methane and hydrogen from this blend under these conditions are 1.1 and 2.3 L/km/day, respectively. For comparison, the permeability of pure methane under similar conditions is 1.4 L/km/day.

Greenhouse Gas Programme Pipeline Leakage Assessment

The IEA Programme performed experimental measurements of the hydrogen permeation coefficient in plastic pipes at 68°F (20°C) (see Table 15 of Appendix A). The hydrogen loss for the Dutch natural gas distribution grid after 17% hydrogen was added is estimated at 0.0005% of the hydrogen transported and therefore was considered insignificant (Haines et al. 2003).

GTI Steel and Ductile Iron Pipe Leakage Assessment

Hydrogen and natural gas leakage in steel or iron pipes primarily occurs through the threads or mechanical joints. The GTI study indicates that the volume leakage rate of hydrogen is three times higher than that of natural gas.

GTI Estimate of Gas Loss in U.S.-Grade Plastic Distribution Pipelines

GTI reviewed U.S. studies on gas loss in plastic distribution pipelines (see Appendix A). The permeation coefficients of hydrogen and methane for the various plastic materials are shown in Table 16 of Appendix A. The hydrogen permeation coefficient in U.S.-grade plastic pipes is five or six times higher than that of methane. GTI performed calculations on gas loss in U.S.-grade plastic pipes for pressures of 60, 3, and 0.25 psig (5.15, 1.22, and 1.03 bar). Results are shown in Table 17 of Appendix A.

Distribution Mains (60 psig [5.15 bar])

Adding 20% hydrogen to natural gas in plastic pipes doubles the total gas loss (77 ft³/mi/yr). Higher concentrations aggravate this effect.

Service Lines

Service pipelines operate at much lower pressure than distribution mains, so the gas loss is much less significant. For pure natural gas, the gas losses are 2.5 and 0.2 ft³/mi/yr at 3 and 0.25 psig (1.22 and 1.03 bar), respectively. Even though a 20% hydrogen mixture doubles the gas loss in the service pipeline, it is still economically insignificant.

Downstream Extraction

This section briefly notes the NaturalHy Project's review of using membranes to separate hydrogen from hydrogen and natural gas mixtures. This is followed by a description of technologies used to extract hydrogen from hydrogen and natural gas mixtures and an estimate of the cost of hydrogen extraction.

NaturalHy Membrane Studies Review

The NaturalHy Project focused on developing advanced hydrogen selective membranes for the separation of hydrogen from natural gas/hydrogen mixtures in Work Package 5 (Task 5.3–5.7). This work was led by the University of Oxford, with participation by the Norwegian University of Science and Technology and Compagnie Europeenne des Technologies del'Hydrogene. For details, see the GTI review of the NaturalHy membrane studies in Appendix A (Task 4.6).

Technologies for Extracting Dilute Hydrogen from a Pipeline

The following sections describe hydrogen extraction technologies for hydrogen and natural gas mixtures of 5%–20%. While we are considering the extraction of hydrogen in high purity for transportation, we have to consider that this differs from traditional separations. Most hydrogen today is produced via steam methane reforming (SMR), where natural gas and steam are used to produce a hydrogen-rich stream via the following reaction:

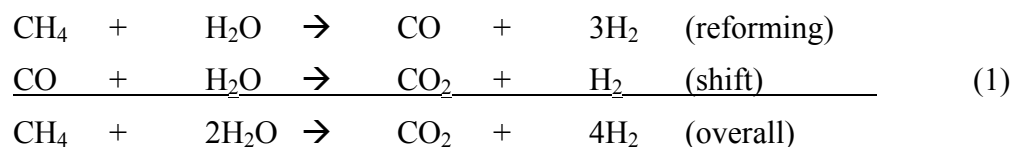

Pressure Swing Adsorption (PSA)

PSA is a well-established technology. The systems are typically produced in sizes of 50 Nm³/h–200,000 Nm³/h. In the above reactions, excess water is used to push the equilibrium to higher hydrogen conversion and discourage side reactions such as coking. The resulting gas mixture is dried by condensing excess steam prior to hydrogen extraction. The dry gas entering the PSA unit has the following approximate composition:

H ₂	=	75%
CO ₂	=	19%
CO	=	3%
CH ₄	=	3%

PSA operates on the adsorption isotherm principle. Every material has a characteristic correlation of surface adsorption of gases versus gas partial pressure. As gas pressure increases, the concentration of adsorbed (immobilized) species on the surface increases. For example, doubling the gas pressure may double the surface concentration of species. In PSA, highly porous packing materials are used. The materials are carefully chosen to adsorb non-hydrogen compounds at elevated pressure (150–300 psig). Multiple materials and layers of packing are typically used, which are tailored to the specific gas composition entering the bed. As reformat gas flows through the packed bed, CO₂, CO, CH₄, and other impurities are retained, while hydrogen passes through the bed. Once the packed bed is saturated, reformat flow is directed to a freshly regenerated bed, and the saturated bed is slated for regeneration. In the regeneration phase, the pressure in the vessel is reduced, thus allowing surface-adsorbed gases to go back in the gas phase. High-purity applications may also utilize hydrogen as a sweep gas to backflow any impurities from the bed. Figure 14 provides a simplified graphical layout of a PSA system.

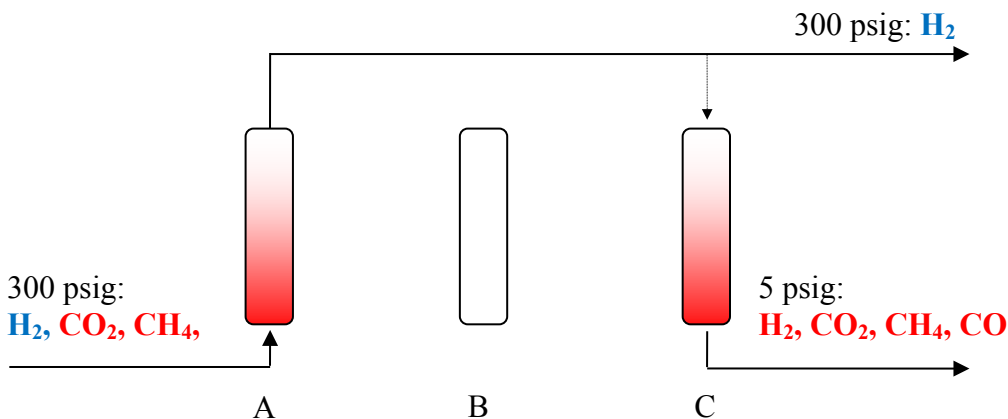

Figure 14. Simplified PSA arrangement.

Notes: Bed A is being actively exposed to reformat. In this bed, all species but H₂ are adsorbed (filtered), and H₂ flows through at high pressure. Once this bed saturates with impurities, flow is directed to a fresh bed (B). Beds are regenerated by reducing the pressure to near-ambient levels and flowing small quantities of product gas to flush impurities.

The cost of PSA units falls into four areas:

- Valving and flow controls
- Vessels
- Packing materials
- Compressors.

PSA technology is the industry standard and works best for high concentrations of hydrogen such as gas streams from conventional SMR production plants, which can be on the order of 75% hydrogen. Many design factors impact a PSA bed embodiment. One important factor to consider is its size vs. level of impurities. The PSA packing layers have two general operating regimes. The upstream portion of the bed is typically saturated with gas during operation and does the bulk of the extraction. The downstream portion of the bed is the fine polishing section of the bed and reduces the concentration of impurities that break through with hydrogen. Thus, the size of the PSA bed is strongly impacted by the concentration of non-hydrogen species entering the bed. For example, if we double the concentration of impurities, a PSA bed would require nearly double the size of the saturation portion of the bed (bulk extraction). The impact is not quite double, as the material saturation point increases for many materials with higher impurity concentration. Additionally, more beds may be required for high concentration impurities. This is due to a higher regeneration period as well as higher temperature swings.

As previously described, PSA units operate by pressure reduction. Gas is provided at high pressure, and impurities are removed at low pressure. In this technology, pressurization of impurities is strictly parasitic as the pressure is not recovered in the regeneration of the bed. As we consider lower concentrations of hydrogen, the concentration of non-hydrogen gas species increases. This means that we would compress larger quantities of gas to recover smaller quantities of hydrogen. For example, in the case of SMR, we would compress approximately 1.3 parts of total gas per 1 part of hydrogen. However, if we consider purification of 10% hydrogen, we would compress 10 parts impurities per 1 part hydrogen. Thus, for equivalent inputs and outputs, our compression work would increase by seven times.

It is notable that typical SMR systems often operate under pressure to avoid bulk gas compression. In such systems, natural gas is taken at pressure from a pipeline, and water is pressurized via liquid pumps (very low auxiliary power). Steam and methane are reacted at pressure to provide high-pressure gas to the PSA units. Hence, the PSA units operate using the pressure of the natural gas pipe and the low pressure of the burner of the SMR unit. This is analogous to conditions found at pressure reduction stations in a natural gas distribution network. In such locations, high pressure gas with potential hydrogen content is present. This gas is taken from transmission pressures as high as 1,000 psig, and pressure is reduced to lower distribution pressures. Gas can be introduced into PSA units at this point for hydrogen extraction, and the beds can be regenerated into the low-pressure distribution lines.

For production of ultra-high-purity hydrogen, the PSA unit can be operated with more frequent cycling of the beds. In such a case, the recovery rate decreases in favor of higher purity product. High-purity hydrogen can also be obtained by a second-stage PSA, which recycles its waste gas

to the bulk PSA extraction of via other purification processes such as membrane purification for gas polishing.

Membrane Separation

Membrane technology is another industry-practiced technology for hydrogen extraction and purification. This technology operates on the principle of selective permeation, by which random motion of molecules across a permeable membrane will equilibrate to equivalent partial pressures on each side of the membrane. For example, if one side of a membrane has 50% hydrogen at 1 atm of absolute pressure, and the opposing side has pure hydrogen, the pressure of the opposing side would be 0.5 atm. The equation for this equilibration would thus be:

$$(2) \quad \begin{array}{ccc} \text{Side A:} & & \text{Side B:} \\ (\text{Total pressure}) * (\text{mol fraction}) & = & (\text{Total pressure}) * (\text{mol fraction}) \end{array}$$

The above equation is for an idealized system, in which the concentrations are equal on both sides. In such a system, the flux is zero, as there is no driving force for gases in either direction across the membrane. To support an appreciable flux, a differential partial pressure of hydrogen would be necessary. For example, the gas pressure of the pure hydrogen side may need to be 0.2 atm, as this would give a driving force of 0.3 atm.

Membrane separation technologies work very efficiently with relatively high hydrogen concentrations. The purity of product gas can be high at very low fractional recovery but monotonically decreases as recovery increases, as the relatively slower co-permeation of impurities proceeds to a greater degree. Most applications using membrane technology industrially recover the bulk hydrogen at 95%–99% purity.

Palladium (Pd) membrane technologies can achieve hydrogen at 99.9999999% purity. At temperatures of approximately 752°F (400°C), Pd efficiently causes hydrogen molecules to dissociate on contact. The resulting protons dissolve into the metal. If the Pd is in the form of a thin membrane and a differential partial pressure is maintained across the membrane, the protons will migrate from the high-pressure side to the low-pressure side, where the protons recombine to form hydrogen atoms. As only hydrogen molecules exhibit this property, extremely pure hydrogen can be obtained from Pd membrane devices.

This technology is employed in the electronics industry to supply hydrogen with a total impurity load in sub-ppb range, and it is being increasingly used in the mobile power market and in renewable fuels research to provide fuel-cell-ready hydrogen from streams of reformat gas.

In practice, the Pd metal is alloyed with another metal to enhance the mechanical strength of the membranes. When copper is included, the resulting membrane can resist degradation by sulfur-bearing compounds at concentrations in the ppm range. Pd micro-channel membrane purifiers would typically be employed in series with a PSA unit and would be used to remove contaminants (for example, CO) that may damage a fuel cell. Pd micro-channel membranes require a hydrogen partial pressure difference to drive the protons through the Pd metal. Typically, a partial pressure of 160–200 psi is optimal (PE 2012).

Dilute hydrogen poses a significant challenge for membrane technology. For example, if 10% hydrogen is fed into a membrane separator, and 70% recovery is being considered, the outlet composition of the gas would be approximately 3%. This means that to support the flux of the outlet elements of the membrane, the pressure ratio would need to be at least 33:1. So, if ambient-pressure hydrogen is recovered, the pressure of the natural gas would need to be at least 33 atm (500 psia). This is, again, an idealized scenario, and a significantly higher ratio than 33:1 would be needed to provide a driving force.

Membrane technology for transmission pipelines may, however, be a good technology fit. Such pipelines often operate at pressures of about 1,000 psig, which provides sufficient driving force for hydrogen extraction. In such systems, the bulk of the process gas retains its pressure, and only a small amount of repressurization would be required to compensate for any device pressure drop.

Electrochemical Hydrogen Separation (Hydrogen Pumping)

Electrochemical Hydrogen Separation (EHS) is a more elaborate method for bulk hydrogen recovery. It operates on principles in common with fuel cell systems, using fuel cell stacks and passing the process gas across one side of the stack. By applying a current across the stack, hydrogen is atomically dissociated from the process gas and is reassociated into hydrogen on the product side. This process operates with very low differential pressure between the process gas and the product gas. Two technologies are used for electrochemical separation: one is based on Nafion and the other on PBI. Nafion is the more mature technology, but PBI is more desirable because the phosphoric acid conditions provide chemical resistance to sulfur contamination and its lower sensitivity to hydration.

PBI membranes require electrical potential to drive substantial current across the stack. As hydrogen concentration differs across the membrane, it needs to be compensated by applying a voltage. Additional voltage is necessary to drive activation, conduction, and diffusion resistances. In the presence of competing adsorption species such as H₂S and CO, the diffusion resistance can increase significantly. This can, however, be balanced with operation at higher temperature (for example, 356°F [180°C]). The power required for EHS is a strong function of the partial pressure of the hydrogen and the total pressure of the product gas. Similar to fuel cell systems, the overpotential required for pumping hydrogen is penalized due to lower hydrogen concentrations. This is exhibited by dilute hydrogen streams requiring higher potentials than concentrated hydrogen streams. Additionally, resistive losses are proportional to the operating current density of the electrochemical separator. At high current density, more resistive losses are experienced. High current density is nevertheless desirable, as the size of the extraction hardware would be smaller and the purity of the resulting gas would be higher. Hydrogen purity is compromised at low current densities due to a constant rate of impurity diffusion across the membrane. At low current density, the diffusion of impurities such as CH₄ would result in a larger fraction in the product. Temperature is another factor of operation. In PBI systems, CO tolerance is accomplished after about 248°F (120°C); beyond that temperature, any CO content of the feed gas degrades performance as a diluent.

EHS systems operating with PBI function with very small differential pressures. High differential pressures are a cause of acid migration in the membrane, which can inactivate the catalytic surfaces of the membrane. However, such a problem is not a major concern when

considering high-pressure pipelines such as transmission or distribution pipelines, which are on the order of 500 to 1,000 psig. Hydrogen would be extracted in such systems via EHS to 500 to 1,000 psig. Subsequent gas polishing may be needed, and could be further accomplished with membrane separation as discussed in the previous section. Gas polishing of this type would have a relatively low pressure drop due to the high partial pressure of the feed gas.

Electrochemical processes operating on phosphoric acid or proton exchange membrane (PEM) platforms require water to operate. Phosphoric acid (in PBI) is more tolerant to dry operation, but in the total absence of water it dehydrates to a solid form that is not ionically conductive. PEMs require even more water to operate as the gas needs to be saturated at the operating temperature and pressure. Addition of water involves a humidification system, while pipeline gases have to be dry. Therefore, a water removal system would be necessary. Additionally, the membranes are susceptible to contamination from sulfur and ammonia. Sulfur is always present; ammonia is rarely seen. In cases of natural gas containing ammonia, an upstream gas separator may be required to remove species such as ammonia and sulfur. Of course, sulfur would also be reinjected in the gas downstream to provide odorization. It is also important to consider that PBI will also produce some phosphoric acid vapors (typically in the form of P_2O_5 or P_4O_{10}). These species are highly corrosive and need to be filtered out of the effluent gasses. This species is relatively easily trapped, however, due to its high reactivity.

It is worth noting the additional potential functionality of proton exchange membranes (PEM). While phosphoric acid cannot support more than 2 psi of differential pressure, PEM systems can operate with differential pressure in excess of 1,000 psi. It is well within the state of the art to operate a PEM when pumping hydrogen from about 15 psi to 1,000 psi. This can be advantageous with other upstream bulk separations (for example, PBI or a diffusion membrane system). In such a case, a PEM can operate in two functions:

- Electrochemical compressor
- High-purity filter.

Electrochemical compression can be especially valuable at small scales where cost scaling factors for compressors become prohibitive. Unlike compressors, the scaling factor for electrochemical compression is much more linear with size. And because the membrane has few moving parts and avoids fuel cell degradation drivers (catalyst oxidation and contamination), maintenance costs would likely be low.

Sulfur and Constituent Considerations

In all the above technologies, sulfur and odorants would largely need to be removed before the process gas enters the purification equipment, and a scrubbing or hydrodesulfurization (HDS) application would be required. HDS may be the ideal technology, as hydrogen is already present in the feedstock. This technology offers a high density of sulfur capturing and a very low slip rate from the scrubber. Downstream, the gas would need to be reodorized by reinjection of mercaptans. This can be a significant hurdle. Deodorizing gas with 10% hydrogen and 70% recovery would mean that 33 parts of gas would need to be deodorized to recover 1 part of hydrogen gas. It is thus worth investigating in more detail which system type might have higher tolerance for sulfur. For example, the industry-standard HDS process typically operates at 600°F (316°C). This is not practical in a pipeline application. HDS would need a burner, recuperator,

and air cooler, with the burner consuming a significant amount of energy. More practical techniques may include metal-doped carbon, damp iron oxide systems, and methyl diethanolamine (MDEA) for large-scale units.

Another major consideration is double-bonded hydrocarbons (ethylene, propylene), which can readily polymerize on many process surfaces and make impermeable coatings. Such components are present in small concentrations in natural gas, and in some pipeline practices (such as propane peak shaving) they can account for more than 1% of the total gas composition. Injection of propane is also likely in case of hydrogen pipelines as heavy hydrocarbons may be used to increase the gas heat content due to it being lowered by hydrogen (Zachariah-Wolff et al. 2007). This is especially challenging for ambient-temperature sulfur-scrubbing technologies, although they are not a significant problem for polymer membranes or PSA.

Oxygen is another constituent sometimes found in pipelines. It is more of an issue downstream from transmission pipelines. For example, gas appliances at high altitudes such as Denver, Colorado, operate more efficiently when premixed with air to compensate for the lower atmospheric oxygen. In this case, air is mixed in at the city gate and would not affect hydrogen transmission along the main line. Oxygen can also be introduced in rare instances such as peak shaving. For example, this is still encountered in areas in the Northeast during peak demands in cold winters. Again, this is typically performed downstream of any transmission line. As both hydrogen and oxygen react instantly on a catalytic surface, EHS would not be able to operate under such conditions. However, oxygen could also be a benefit by reacting with hydrogen to form water on the membrane surface. This water is beneficial as the membrane needs to be hydrated to operate, but is a hazard due to the associated exothermic reaction. As oxygen injection is a rather rare practice, system selection would be a function of local conditions.

Cost Estimate of Hydrogen Extraction from a Distribution Natural Gas Pipeline

NREL performed a cost estimate of hydrogen extraction from a distribution natural gas pipeline employing PSA units. We used Directed Technologies, Inc.'s (DTI) PSA capital cost estimate (DTI 2011) and H2A (DOE 2012) economic assumptions to develop the extraction cost modeling.

DTI's capital cost estimate for PSA units is based on the Nth plant concept, which reflects a mature system that is functionally reliable in the field and has been produced in sufficiently high annual and cumulative quantities as to have a capital cost (and unit cost) close to its asymptotic limit. At low manufacturing volumes, capital costs are high due to relatively time-intensive manufacturing and assembly methods. As the manufacturing rate increases, more efficient production methods become economical, capital cost (per unit output) decreases, and unit cost decreases. At extremely high manufacturing rates, all possible cost improvements have been achieved, and production rates are increased only by replicating process machinery. At those levels, capital cost (per unit output) and unit cost flatten in relation to the manufacturing rate.

The Nth plant assumption affects the H2A cost computations in two ways. The primary effect is in the estimated value of plant capital cost. The capital cost used in the H2A computation should not pertain to the initial or "one off" cost of a system, but rather to a relatively mature system produced in high volumes. Blended into the capital cost estimate are factors such as bulk

discounts on material costs and low-cost manufacturing and assembly methods. These are made possible by serial production of the systems, efficient and streamlined business operations, and a lower profit margin consistent with a mature product that must be priced competitively.

We assess only the cost of hydrogen extraction here. The other costs (injection cost, hydrogen losses along the pipeline, capital cost increase caused by underutilization during lag-in-demand seasons, analytical costs, etc.) are not accounted for here.

The estimated cost of hydrogen extraction by PSA from a 300-psi pipeline is shown in Figure 15. The hydrogen recovery factor from PSA is assumed to be 80%. For a 10% hydrogen concentration, the extraction cost is \$3.3–\$8.3/kg of hydrogen extracted, depending on the scale of extraction or recovery rate in kg/day, as shown in Figure 15. For a 20% hydrogen concentration, the extraction cost across the same scale of extraction drops to \$2.0–\$7.4/kg. The high cost of hydrogen extraction from a natural gas pipeline is largely due to high capital costs. For example, for a 10% hydrogen pipeline, the capital cost contribution to the levelized cost of hydrogen extraction is 61% (Figure 16), 66% of which is the cost of the compressor (Figure 17). Gas pressure at the PSA exit is about 2 atm (30 psi). If hydrogen is extracted from a pipeline at 300 psi, the separated natural gas has to be recompressed back to the pipeline. Due to low concentrations of hydrogen, the amount of natural gas that has to be recompressed is high and requires a large compressor.

High recompression costs can be avoided if hydrogen is extracted at a pressure-reduction facility so natural gas does not need to be recompressed. Pressure differentials can vary between pressure-reduction facilities, but are often significant at the city gate where transmission lines feed into distribution lines. The hydrogen extraction cost for a 10% hydrogen blend under these circumstances is 6 to 11 times lower (\$0.3–\$1.3/kg of hydrogen extracted) depending on the scale of extraction or recovery rate in kg/day, as shown in Figure 18. These extraction costs were modeled for a pressure drop from 300 to 30 psi. Based on this significant cost reduction, it appears that hydrogen extraction from a natural gas distribution pipeline at a pressure-reduction facility will prove to be a lower-cost option, mostly due to the fact that natural gas exiting the PSA unit would require minimal or no recompression.

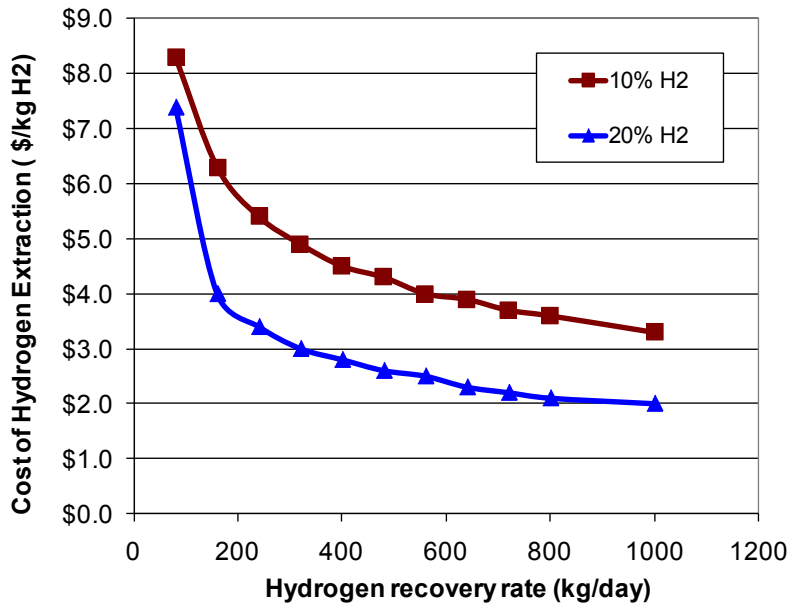

Figure 15. Estimated cost of hydrogen extraction by PSA unit from 300 psi natural gas distribution pipeline (assumed hydrogen recovery factor is 80%).

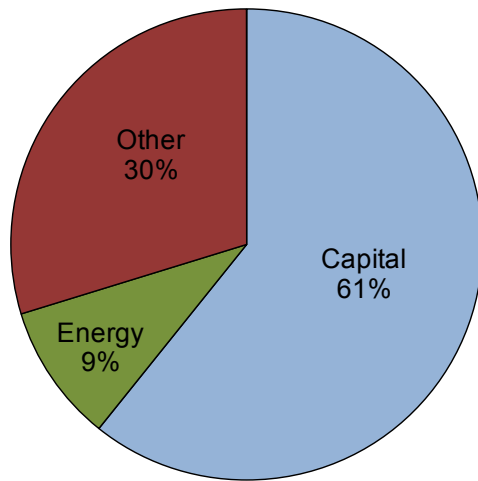

Figure 16. Hydrogen extraction cost breakdown.

Extraction by PSA unit from 300 psi natural gas distribution pipeline with 10% hydrogen added. The hydrogen recovery rate is 100 kg/day and the assumed hydrogen recovery factor is 80%. Cost items in the Other category include labor and O&M.

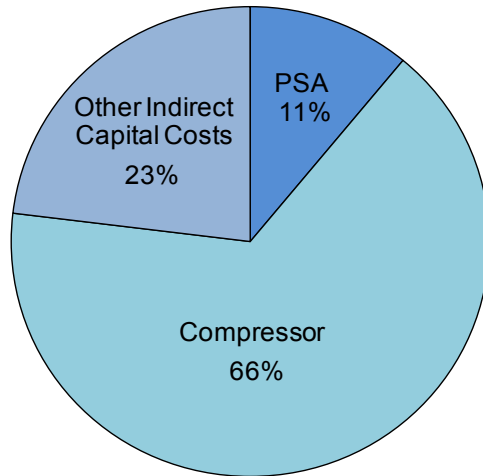

Figure 17. Breakdown of capital cost contribution to the hydrogen extraction cost.
 Extraction by PSA unit from 300 psi natural gas distribution pipeline with 10% hydrogen added. The hydrogen recovery rate is 100 kg/day and the assumed hydrogen recovery factor is 80%. Other Indirect Capital Costs include land, engineering and design, and permitting.

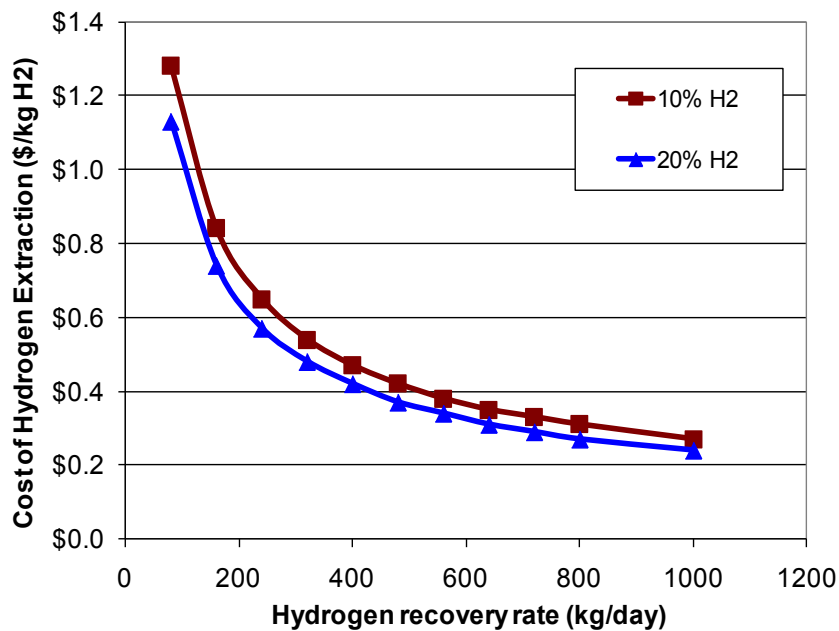

Figure 18. Estimated cost of hydrogen extraction by PSA unit at the pressure-reduction facility (from 300 psi to 30 psi).
 Assumed hydrogen recovery factor is 80%.

Summary and Recommendations

Blending hydrogen into natural gas pipeline networks at low concentrations has the potential to increase output from renewable energy production facilities in the near term. In the longer term, blending may provide an economic means of hydrogen delivery when the hydrogen is injected upstream and then extracted downstream for use in fuel cell electric vehicles (FCEVs) or stationary fuel cells. This report reviews several studies of hydrogen blending and provides an

assessment specific to the U.S. natural gas pipeline system, included in Appendix A. The implications of hydrogen blending vary with the concentration of hydrogen. Relatively low concentrations of hydrogen, 5%–15% by volume, appear to be feasible with very few modifications to existing pipeline systems or end-use appliances. However, this assessment of feasibility will vary from location to location. Higher concentrations introduce additional challenges and required modifications. Preliminary cost estimates suggest that hydrogen could be extracted economically at pressure regulation stations. For a station with a pressure drop from 300 to 30 psi, we estimate an extraction cost ranging from \$0.3–\$1.3 per kg hydrogen for a 10% hydrogen blend, depending upon the capacity and recovery rate.

This report reviews seven key issues concerning blending hydrogen into natural gas pipeline networks: (1) benefits of blending, (2) extent of the U.S. natural gas pipeline network, (3) impact on end-use systems, (4) safety, (5) material durability and integrity management, (6) leakage, and (7) downstream extraction. These issues are interrelated, but are addressed separately for the sake of clarifying explanation. The first two issues place the concept of blending in context. Issues 3–5 impose restrictions on the acceptable level of hydrogen blending, with requirements for end-use systems imposing the greatest restrictions.

Extensive recommendations for future work to better understand the potential costs and benefits associated with hydrogen blending have been proposed in other studies, particularly in the NaturalHy project funded by the European Commission (Florisson 2012). For additional work on the concept of blending renewable hydrogen into the U.S. natural gas pipeline system, we recommend the following:

1. Research and analysis of the costs associated with modifying U.S. pipeline integrity management systems to accommodate different levels of hydrogen blending.
2. Development of case studies assessing the pipeline system modifications required for specific U.S. regions at multiple hydrogen blend levels.
3. Detailed assessment of the impact of hydrogen blending on U.S. end-use systems, such as household appliances and power production technologies (i.e., engines and turbines).
4. Analysis of hydrogen blending in the near term (e.g., 5–10 years) as a means of economically increasing the output of renewable energy production facilities.
5. Dynamic analysis of the role of natural gas and hydrogen storage in future scenarios where hydrogen blending is prevalent in the U.S. natural gas systems.
6. Analysis of the role of hydrogen blending as a least-cost delivery option in the development of a hydrogen infrastructure for fuel cell electric vehicles.
7. Consideration of hydrogen blending as a strategic option to increase the public benefit derived from the existing U.S. natural gas infrastructure, with a focus on long-term implications for energy supply, energy security, integration of renewable natural gas, and greenhouse gas reductions.

References

- Burgherr, P.; Hirschberg, S. (2008). "Severe Accident Risks in Fossil Energy Chains: A Comparative Analysis." *Energy* (33); pp. 538-553.
- Burgherr, P.; Eckle, P.; Hirschberg, S. (2012). "Comparative Assessment of Severe Accident Risks in the Coal, Oil and Natural Gas Chains." *Reliability Engineering and System Safety* (105); pp. 97-103.
- Castaneda, C.J. (1999). *Invisible Fuel: Manufactured and Natural Gas in America, 1800-2000*. New York: Twayne Publishers.
- Campbell, L.M.; Stapper, B.E. (1996). *Methane Emissions from the Natural Gas Industry, Volume 10: Metering and Pressure Regulating Stations in Natural Gas Transmission and Distribution*. Radian International LLC, GRI-94/0257.27, EPA-600/R-96-080j. http://epa.gov/gasstar/documents/emissions_report/10_metering.pdf.
- DOE (2012). U.S. Department of Energy (DOE), Hydrogen Analysis (H2A) website: www.hydrogen.energy.gov/h2a_analysis.html.
- DTI (2011). Directed Technologies, Inc. (DTI), private communications.
- De Vries, H.; Florisson, O.; Thiekstra, G.C. (2007). "Safe Operation of Natural Gas Appliances Fueled with Hydrogen/Natural Gas Mixtures (Progress Obtained in the NaturalHy-Project)." Presented at the International Conference on Hydrogen Safety, September 11-13, San Sebastian, Spain. http://conference.ing.unipi.it/ichs2007/fileadmin/user_upload/CD/PAPERS/13SEPT/6.0.00.pdf.
- De Vries, H. (2009). NaturalHy Project, Final Presentation, October. www.naturalhy.net/.
- E.ON. (2011). "E.ON examines options for storing wind power in the German gas grid." November 11, 2011. E.ON company website, Dusseldorf, Germany. Retrieved May 11, 2012: <http://www.eon.com/en/media/news/press-releases/2011/11/11/e-dot-on-examines-options-for-storing-wind-power-in-the-german-gas-grid.html#>.
- EIA (2011). "Annual Energy Review 2010." U.S. Energy Information Administration (EIA). www.eia.doe.gov/emeu/aer/contents.html.
- EIA (2012). "About U.S. Natural Gas Pipelines." U.S. Energy Information Administration. http://www.eia.gov/pub/oil_gas/natural_gas/analysis_publications/ngpipeline/index.html.
- EPA (2012). *ANNEX 3 Methodological Descriptions for Additional Source or Sink Categories, U.S. Environmental Protection Agency, Annex to the Inventory of U.S. Greenhouse Gas Emissions and Sinks: 1990-2010*. Report number EPA 430-R-12-001. U.S. Environmental Protection Agency. <http://www.epa.gov/climatechange/ghgemissions/usinventoryreport.html>.
- Florisson, O. (2009). "NATURALHY, an Overview." Presented at the NATURALHY Final Public Presentation, November 19, Nederlandse Gasunie at Groningen, The Netherlands.
- Florisson, O. (2010). *Preparing for the Hydrogen Economy by Using the Existing Natural Gas System as a Catalyst*. NaturalHy project Report SES6/CT/2004/502661. http://www.naturalhy.net/docs/project_reports/Final_Publishable_Activity_Report.pdf.
- Florisson, O. (2012). NaturalHy website. <http://www.naturalhy.net/>.

GM (2010). “GM Looks to Hawaii for Hydrogen Infrastructure Pilot.” General Motors News, May 11, 2010. Retrieved May 12, 2011: http://media.gm.com/media/us/en/gm/news.detail.html/content/Pages/news/us/en/2010/May/0511_hawaii.html.

GPO (2011). Code of Federal Regulations: Title 49 - Transportation, Vol. 3, Section 192.5 - Class locations. October 1. <http://www.gpo.gov/fdsys/pkg/CFR-2011-title49-vol3/xml/CFR-2011-title49-vol3-sec192-5.xml>.

GSE (2011). Golden State Energy, private communication.

Haines, M.R.; Polman, W.; de Laat, J.C. (2003). “Reduction of CO₂ Emissions by Addition of Hydrogen to Natural Gas.” Presented at the 2004 Greenhouse Gas Control Technologies conference, Vancouver, Canada. <http://www.ghgt.info/>.

Hirschberg, S.; Burgherr, P.; Speikerman, G.; Dones, R. (2004). “Severe Accidents in the Energy Sector: Comparative Perspective.” *Journal of Hazardous Materials* (11); pp. 57-65.

Holdren, J.P.; Smith, K.R.; Morris, G. (1979). “Energy: Calculating the Risks (II).” *Science* (204:4393); pp. 564-568.

Holdren, J.; Morris, G.; Mintzer, I. (1980). “Environmental Aspects of Renewable Energy-Sources.” *Annual Review of Energy* (5); pp. 241-291.

Hydrogenics (2012a). “Hydrogenics Announces Agreement with Enbridge to Develop Utility Scale Energy Storage in North America.” Hydrogenics News Release, April 20. http://www.hydrogenics.com/invest/News_Details.asp?RELEASEID=666521.

Hydrogenics (2012b). “Hydrogenics Wins Order from E.ON for ‘Power-to-Gas’ Energy Storage Project in Germany.” Hydrogenics News Release, June 1. http://www.hydrogenics.com/invest/News_Details.asp?RELEASEID=678878.

IEA (2012). International Energy Agency, Greenhouse Gas R&D Programme website: www.ieaghg.org/.

IGT (1972). *A Hydrogen–Energy System*. Institute of Gas Technology, report prepared for the American Gas Association, Catalog No. L21173, August.

Jasionowsky, W.J. (1980). *Study of the Behavior of Gas Distribution Equipment in Hydrogen Service-Phase II*. Gas Technology Institute report.

Lowesmith, B. (2009). “Adding Hydrogen to the Natural Gas Infrastructure: Assessing the Risk to the Public.” NaturalHy Project, Final Public Presentation, November 19. http://www.naturalhy.net/index.php?option=com_content&view=article&id=52:workshop-presentations&catid=35:workshop-presentations&Itemid=44.

Lowesmith, B.J.; Mumby, C.; Hankison, G.; Puttock, J.S. (2011). “Vented Confined Explosions Involving Methane/Hydrogen Mixtures.” *International Journal of Hydrogen Energy* (36:3); pp. 2337-2343.

Melaina, M. (2012). “Market Transformation Lessons for Hydrogen from the Early History of the Manufactured Gas Industry.” Grasman, S.E., ed. *Hydrogen Energy and Vehicle Systems*. CRC Press (forthcoming).

PE (2012). Power & Energy company website: www.powerandenergy.com/h2purifiers-9000mz-series.html.

PHMSA (2012). "Natural Gas Transmission, Gas Distribution, and Hazardous Liquid Pipeline Annual Mileage." U.S. Department of Transportation Pipeline and Hazardous Materials Safety Administration.
<http://phmsa.dot.gov/portal/site/PHMSA/menuitem.ebdc7a8a7e39f2e55cf2031050248a0c/?vgnextoid=036b52edc3c3e110VgnVCM1000001ecb7898RCRD&>.

Polman, E.; de Laat, H.; Stappenbelt, J.; Peereboom, P.; Bouwman, W.; de Bruin, B; Pulles, C.; Hagen, M. (2003). *Reduction of CO₂ Emissions by Adding Hydrogen to Natural Gas*. GASTEC, Netherlands, IEA Report PH4/24, October.

PSI (2012). "Comparative Risk Assessment and the ENSAD Database." Paul Scherrer Institute (PSI). <http://gabe.web.psi.ch/research/ra/>.

Ruth, M.; Joseck, F. (2011). "Hydrogen Threshold Cost Calculation, DOE Program Record # 11007." U.S. Department of Energy, March.
http://www.hydrogen.energy.gov/pdfs/11007_h2_threshold_costs.pdf.

Schmura, E.; Klingenberg, M. (2005). "Existing Natural gas Pipeline Materials and Associated Operational Characteristics." Presented at the Annual Merit Review Meeting of the U.S. Department of Energy's Hydrogen and Fuel Cells Program, Washington, D.C., May 23-26.

Schneider, S.H. (1979). "Comparative Risk Assessment of Energy Systems." *Energy* (4:5); pp. 919-931.

Tarr, J.A. (2004). "History of Manufactured Gas." *Encyclopedia of Energy* (3); pp. 733-743.

TGC (2012). The Gas Company, Honolulu, Hawaii. Company website: www.hawaiiigas.com.

Weitz, M. (2012). "Current U.S. Inventory Methods and Key Areas for Updates, Distribution Sector." Presented at the Stakeholder Workshop on Natural Gas in the Inventory of U.S. Greenhouse Gas Emissions and Sinks, conducted by the U.S. Environmental Protection Agency, September 13-14, 2012.
<http://www.epa.gov/climatechange/ghgemissions/Sept2012stakeholderworkshop/Agenda.html>.

Williamson, H.; Daum, A.; Klose, G.; Andreano, R. (1959). *The American Petroleum Industry: The Age of Illumination 1859-1899*. Evanston, Illinois: Northwestern University Press.

Wilson, D. (2012). "Power-to-Gas: Utility Scale Energy Storage." Presentation to the Hydrogen Technical Advisory Committee, May 10.
http://www.hydrogen.energy.gov/pdfs/htac_may2012_hydrogenics.pdf.

Zachariah-Wolff, J.L.; Egyedi, T.M.; Hemmes, K. (2007). "From Natural Gas to Hydrogen Via the Wobbe Index: The Role of Standardized Gateways in Sustainable Infrastructure Transitions." *International Journal of Hydrogen Energy* (32); pp. 1235-1245.

Zhou, Z.; Ersoy, D. (2010). *Review Studies of Hydrogen Use in Natural Gas Distribution Systems*. Gas Technology Institute, Project Number 21029. Report to the National Renewable Energy Laboratory (Appendix A of the present report).

Appendix A: GTI Subcontract Report to NREL “GTI Review Studies of Hydrogen Use in Natural Gas Distribution Systems”

FINAL REPORT

GTI PROJECT NUMBER 21029

Review Studies of Hydrogen Use in Natural Gas Distribution Systems

Reporting Period:

June 15, 2010 to Oct. 15, 2010

Report Issued (Period Ending):

Oct. 15, 2010

Rev. No. 2: Dec. 16, 2010

Prepared For:

National Renewable Energy Laboratory
Olga Sozinova
Technical Monitor
1617 Cole Blvd., Golden, CO 80401
303-275-3755
Olga.sozinova@nrel.gov

Prepared By:

Zhongquan Zhou
Principal Investigator
zhongquan.zhou@gastechnology.org
847-768-0901

Daniel Ersoy
Project Manager
daniel.ersoy@gastechnology.org
847-768-0663

Gas Technology Institute
1700 S. Mount Prospect Rd.
Des Plaines, Illinois 60018
www.gastechnology.org

Signature Page

*Print or typed
First M. Last*

Signature

Date

AUTHOR:

Ms. Zhongquan Zhou



2010-10-14

Principal Investigator/Principal

Title: Engineer

REVIEWED BY:

Mr. Daniel Ersoy



2010-10-14

Title: Project Manager/R&D Director

APPROVED BY:

Mr. Daniel Ersoy



2010-10-14

Title: Project Manager/R&D Director

Legal Notice

This information was prepared by Gas Technology Institute (“GTI”) for National Renewable Energy Laboratory (NREL) (Contract Number: AEV-0-40629-01).

Neither GTI, the members of GTI, the Sponsor(s), nor any person acting on behalf of any of them:

- a. Makes any warranty or representation, express or implied with respect to the accuracy, completeness, or usefulness of the information contained in this report, or that the use of any information, apparatus, method, or process disclosed in this report may not infringe privately-owned rights. Inasmuch as this project is experimental in nature, the technical information, results, or conclusions cannot be predicted. Conclusions and analysis of results by GTI represent GTI's opinion based on inferences from measurements and empirical relationships, which inferences and assumptions are not infallible, and with respect to which competent specialists may differ.*
- b. Assumes any liability with respect to the use of, or for any and all damages resulting from the use of, any information, apparatus, method, or process disclosed in this report; any other use of, or reliance on, this report by any third party is at the third party's sole risk.*
- c. The results within this report relate only to the items tested.*

Table of Contents

	Page
Signature Page	i
Legal Notice	ii
Table of Contents.....	iii
Table of Figures	vi
List of Tables	vii
Executive Summary	1
Introduction	3
Overview – Natural Gas Distribution System in US	5
<i>US Natural Gas Pipeline Infrastructure</i>	5
<i>Comparison of Transmission and Distribution Systems</i>	5
<i>Piping Materials of Distribution Network</i>	5
<i>Elastomeric Sealing Materials in Distribution Network</i>	6
<i>Operating Pressure of Distribution Network</i>	6
<i>Typical Failure Mechanism of Distribution Pipelines</i>	6
<i>Locations of Distribution Infrastructure Facilities</i>	7
<i>Safety Records</i>	7
Task 4.1 – Life Cycle Assessment	9
<i>Life Cycle and Socio-Economic Assessment Literature [1]</i>	9
<i>Standard Procedures for Life Cycle and Socio-Economic Assessment [2]</i>	9
<i>Overall Benefits of Adding Hydrogen to Natural Gas [2]</i>	10
<i>Summary on Life Cycle and Socio-Economic Assessment</i>	10
Task 4.2 – Safety	12
<i>Risk Assessment by NaturalHy Project (Work Package 2) [3]</i>	12
The Impact on the Likelihood of Incident by Adding Hydrogen:	12
The Impact on the Consequence of an Incident by Adding Hydrogen:.....	12
Risk Assessment:.....	13
<i>Overall Safety Effect by Adding Hydrogen to Natural Gas Network (Greenhouse Gas Programme, IEA [11])</i>	13
<i>Risk Assessment for US Natural Gas Distribution Systems under Hydrogen Service</i>	13
<i>Summary and GTI’s Concluding Remarks on Safety</i>	15
Task 4.3 – Leakage Assessment	16
<i>Assessment of Permeation Loss by NaturalHy Project (Work Package 3) [3, 18]</i>	16

<i>Additional Information on Leakage Assessment</i>	17
Gas Leakage from Steel or Ductile Iron Systems [19]:	17
Gas Leakage from Plastic Pipes and Elastomers [11, 13, AGA handbook].....	17
<i>Leakage Assessment by IEA Greenhouse Gas Programme [11]</i>	17
<i>Estimation of Gas Loss for US Distribution Network</i>	17
<i>Summary and GTI’s Concluding Remarks on Gas Leakage</i>	18
Task 4.4 – Durability	20
<i>Durability (NaturalHy Projects-Work Package 3) [8, 17, 18]</i>	20
Hydrogen Affect on the Initiation and Growth of Defects in Transmission Pipelines	21
Hydrogen Permeation in Plastic Pipes in Distribution Network	21
Aging of Plastic Pipes in Hydrogen/Natural Gas Blends	21
The Reliability of Gas Meters for Hydrogen Services	21
<i>Additional Information for the Durability of Pipeline Materials under Hydrogen Services</i>	21
Hydrogen Damage of Metals	21
Hydrogen Impact on Steel Linepipe	22
<i>Hydrogen Embrittlement of Steel Pipe [11]</i>	22
<i>Hydrogen Assisted Fatigue [13]</i>	22
<i>Enhanced Crack Growth on Existing Defects [11]</i>	22
<i>Welding Requirements for Hydrogen Services [13]</i>	22
Hydrogen Impact on Non-Metallic Materials.....	22
<i>Compatibility of Polymer Materials with Hydrogen [13]</i>	22
<i>Hydrogen Permeability in Plastics [11]</i>	23
Impact of Hydrogen on the Durability of Gas Meters [11]	23
<i>Summary and GTI’s Concluding Remarks on Durability</i>	23
Impact of Hydrogen on the Durability of Metallic Pipes in Distribution Systems	23
Impact of Hydrogen on the Durability of Plastic Pipes and Elastomers in Distribution Systems	23
Impact of Hydrogen on the Durability of Gas Meters	24
Task 4.5 - Integrity	25
<i>Integrity Management Program for Transporting Hydrogen/Natural Gas Mixtures [4,5,6]</i>	25
Defects in Natural Gas Pipeline Systems and the Potential Impact by Hydrogen.....	25
Impact of Hydrogen on the Defect Criticality	26
Inspection/Monitoring Tools and Inspection Intervals	26
Cathodic Protection (CP) Integrity Management	26
Repair Methods.....	26
Cost of the Integrity Management for Hydrogen Service	26
<i>Additional Information for Distribution Pipeline Integrity under Hydrogen Services</i>	26

Major Threats to Distribution Infrastructure	26
<i>Summary and GTI’s Concluding Remarks on the Integrity under Hydrogen Services</i>	27
Conclusions in NaturalHy Project on Transmission Pipeline Integrity	27
GTI’s Comments on Distribution Integrity.....	28
Task 4.6 - End Use-Hydrogen Separation.....	29
<i>Development of High Selectivity Palladium-Based Membranes</i>	29
<i>Development of Carbon-Based Membranes</i>	29
Carbon Molecular Sieves (CMS).....	30
A Mixed Matrix (MM) Material	30
<i>Development of Hybrid Membrane Separation System</i>	30
<i>Summary on Hydrogen Separation Technologies</i>	30
Task 4.7 – Impacts (Environmental and Macroeconomic Benefits)	31
Conclusions	32
References	67
List of Acronyms	72
List of Acronyms	73

Table of Figures

	Page
Figure 1. Schematic of the Natural Gas Delivery Pipeline Infrastructure*	35
Figure 2. Piping Materials of Mains and Service Lines in Distribution Systems*	36
Figure 3. The Distribution of Pipe Size of Steel and PE Pipes in Distribution Mains*	37
Figure 4. The Distribution of Pipe Size of Steel and PE Pipes in Service Lines*	38
Figure 5. Statistical Data for Leak Incidents in Distribution Mains and Service Lines*	39
Figure 6. Incidents by Part of the Distribution System*	40
Figure 7. Serious Incidents by Construction Materials of Mains*	41
Figure 8. Serious Incidents in Steel and Polyethylene Service Lines by Cause*	42
Figure 9. The Calculated Gas Loss Rate vs. Hydrogen Concentration in Hydrogen/Methane Mixtures at the Typical Distribution Operating Pressures (60 psig (4.1 bar), 3 psig (210 mbar) and 0.25 psig (17.2 mbar))*	43
Figure 10. The Calculated Gas Loss from the Gas Mixtures Containing Different Levels of Hydrogen in Distribution System at 60 psig (4.1 bar) Operating Pressure	44
Figure 11. A Hybrid Separation Membrane System for Hydrogen Recovery*	45

List of Tables

	Page
Table 1. Regulation Mandated Inspection of Gas Pipeline Facilities*	46
Table 2. Pipe Sizes and Materials in Distribution Systems*	48
Table 3. Steel Grades for Distribution Pipelines and Their Material Properties*	49
Table 4. Elastomers in Natural Gas Distribution System*	50
Table 5. Number of Leak Incidences by Causes for Distribution Mains and Services*	51
Table 6. The cause of Transmission and Distribution Incidents*	52
Table 7. Coverage of Technology Areas in the Literature Database*	53
Table 8. Effect of Hydrogen Addition in Natural Gas on Gas Properties and Hazards*	54
Table 9. Ranking of the Hazards in Natural Gas Distribution Systems*	55
Table 10. The Risk Factor ^a for Pipe Material Categories and the Overall Risk Factor ^b at Each Failure Modes in Distribution Mains	56
Table 11. The Risk Factor ^a for Pipe Material Categories and the Overall Risk Factor ^b at Each Failure Modes in Service Lines	57
Table 12. Risk Assessment for Distribution Mains at Three Hydrogen Levels	58
Table 13. Risk Assessment for Distribution Services at Three Hydrogen Levels	59
Table 14. The Permeation Coefficient and the Calculated Gas Loss from a 32 mm (1.26") PE80 Pipe Under the Pressures of (58 psig (4 bar), 116 psig (8 bar) and 174 psig (12 bar))*	60
Table 15. Permeation Coefficient ($10^{-3} \times \text{ft}^3\text{-mil/ft/day/psig}$) of Hydrogen Gas for Plastic Pipe Materials at 20°C*	61
Table 16. Permeation Coefficient ($10^{-3} \times \text{ft}^3\text{-mil/ft/day/psig}$) of Hydrogen in Plastic Pipe and Elastomeric Materials	62
Table 17. The Calculated Gas Loss Rate ($\text{ft}^3\text{/mile/year}$) Based on Literature Data for HDPE Pipes at the Operating Pressures of 60 psig, 3 psig and 0.25 psig*	63
Table 18. Classification of Hydrogen Degradation of Metals*	64
Table 19. Hydrogen Compatibility of the Plastics and Elastomers Used in Natural Gas Pipeline*	65
Table 20. Operator Perceptions on Threat Significance*	66

Executive Summary

There is an extensive natural gas pipeline network in the United States. Some studies suggest that it could be a viable solution for the early market to partially use existing natural gas pipelines to deliver hydrogen, mixing it with natural gas in certain proportions, and then separate and purify it for use by an end consumer.

The existing natural gas pipeline networks include the gathering, transmission and distribution pipeline systems. It is considered that hydrogen can be injected into natural gas transmission pipelines and delivered to end users through distribution networks. As hydrogen and natural gas differ significantly in their physical properties, addition of hydrogen to the natural gas pipeline systems must be acceptable in terms of safety and integrity of the network.

In order to assist the development of a delivery go/no-go decision on the use of existing natural gas infrastructure to transport hydrogen from production to end users, GTI performed this literature review for National Renewable Energy Laboratory (NREL) to provide the scientific basis and engineering assessment on some of the aspects related to adding hydrogen in natural gas distribution systems. The scope of this review covers the seven aspects that have been investigated in NaturalHy including “Life Cycle Assessment”, “Safety”, “Leakage Assessment”, “Durability”, “Integrity”, “End Use” and “Environmental and Macroeconomic Impacts”.

In this study, GTI reviewed the available studies related to using the existing natural gas pipeline for hydrogen transportation. The primary focus was on the studies performed by the *NaturalHy Project*. GTI also provided a summary and discussion related to the use of the natural gas network for hydrogen service. This included analysis of the report from the Greenhouse Gas R&D Programme sponsored by the International Energy Agency (IEA) and related results from this study and other publications. The results from this study indicate that adding hydrogen into natural gas has beneficial effects on the environment by reducing greenhouse emissions and air pollutions. But there is not enough information from currently available literature sources to support benefits to the economy and employment.

In addition to the report from the NaturalHy Project, GTI included additional literature sources on material performance in hydrogen environments. GTI provided a scientific basis for assessing the durability and integrity of the existing pipeline infrastructure and potential gas leakage under hydrogen service. The reviewed information finds that there is no major impact from hydrogen on the material integrity under natural gas distribution operating conditions. However, hydrogen leakage through plastic pipe materials and elastomers is much higher than methane, and this may become a safety concern in a confined space where accumulation of the gas may increase the likelihood and severity of a fire or explosion.

GTI performed a quantitative risk assessment based on the current natural gas distribution system using the statistical data of US distribution system incidents, together with the survey results on the significant threats in distribution systems provided by utility operators. Using the risk of the system under natural gas service as a baseline, the overall risks at three hydrogen levels (<20%, 20 to 50%, and >50%) were assessed using the results from NaturalHy and other literature sources.

Compared to the current situation with natural gas, the risks present by natural gas distribution systems are increased by adding hydrogen into the system. The impact depends on the hydrogen concentration in the gas mixtures. If less than 20% hydrogen is introduced into the distribution system, the overall risk is not significant, though having hydrogen in natural gas has more impact on the safety in service lines than mains. If the hydrogen level in natural gas increases beyond 20%, the overall risk in service lines can significantly increase and the potential hazards can become severe, while the overall risk in distribution mains still can be moderate up to 50%. For hydrogen level above 50% in natural gas, the risks in both distribution mains and service lines significantly increase, and the overall risk in distribution system becomes unacceptable.

The study of the influence on pipeline integrity by adding hydrogen in the NaturalHy Project focuses on transmission pipelines. It cannot easily be applied to distribution systems because these systems are inherently different from transmission pipelines. The level of hydrogen that is acceptable for transmission pipelines may need to be reassessed for distribution systems in terms of the frequency and severity of fire or explosion in populated areas.

In addition, the hazards arising from gas leakage in a distribution system can be more severe than with transmission pipelines, especially in a confined service area. The integrity management for distribution systems under hydrogen services may require the implementation of a leak detecting or monitoring device or sensor. Currently, there is no available odorant for hydrogen, and this remains a gap to be further investigated.

It is likely that the maintenance costs for distribution systems under hydrogen service will be increased due to the needs for increased inspection frequency and leak detection. Since there is no existing integrity program for distribution system (although a new federal mandate is just being implemented), it is difficult to determine the stepwise maintenance cost of adding hydrogen.

Currently, the membranes used for extracting hydrogen from hydrogen/natural gas mixtures are under development. It is indicated by a recent study that extracting hydrogen from the gas mixture will not adversely affect the downstream gas quality since the Wobbe index and heating value will not be outside statutory requirements.

Electroless plated palladium membranes and carbon molecular sieves (CMS) are two promising technologies that are being considered for further development. Palladium membranes can provide high purity hydrogen, but they are expensive and have to operate at 300°C. CMS membranes are low cost and can operate at temperatures between 30°C and 90°C, but the maximum hydrogen content obtained using CMS membranes is 98%. The most promising future technique would be a hybrid separation system consisting of both palladium and CMS membranes.

Introduction

Hydrogen is considered as an important energy carrier in the future for sustainable, reliable and cost-effective energy. As an energy carrier, hydrogen will provide a secure energy supply by utilizing locally available energy resources such as wind, solar, biogas, nuclear, etc.

One of the main barriers to moving towards a hydrogen economy is developing a reliable and cost-effective hydrogen delivery system. Compared with trucks and trains, pipeline transportation and distribution systems are considered as a safe, environmentally friendly and cost effective way to move hydrogen from its production location to its end users. However, the cost to construct a new widespread pipeline system for hydrogen delivery is huge and it may take decades to complete.

A cost effective transitional hydrogen delivery system would be to use the existing natural gas pipeline network, which offers advantages such as being: (a) widely spread and interconnected, (b) very high capacity, (c) well developed maintenance and control structure, (d) well established safety procedures, (e) well established grid management and operation strategies, and (g) broad acceptance by the public.

Because the physical and chemical properties of hydrogen are quite different from natural gas, the existing natural gas pipeline system is not suitable for delivery of pure hydrogen without significant modifications. However the existing natural gas pipeline system may be able to be used for co-transporting hydrogen with natural gas (i.e., a mixture) with no or minor modifications of the pipeline design, operation, and maintenance. This hydrogen/natural gas mixture could then be used in end user's systems, given appropriate modifications of the appliances, or could be used as pure hydrogen by developing devices to extract hydrogen selectively from the mixture.

Existing natural gas pipeline networks are made up of the gathering, transmission, and distribution pipeline systems. Hydrogen would be injected into natural gas transmission pipelines and delivered to end users through distribution networks.

GTI performed a literature review for the National Renewable Energy Laboratory (NREL) to provide the scientific basis and engineering assessment on the potential for adding hydrogen to natural gas distribution systems. The review is broken down into seven (7) subtasks:

- **Task 4.1: Life Cycle Assessment:**

The review in this task includes the major natural resource inputs and environmental outputs, socio-economic assessments of employment and economic costs for: (a) current natural gas and related energy systems, (b) transitional natural gas/hydrogen systems, and (c) future complete hydrogen systems.

- **Task 4.2: Safety**

Review the impact of adding hydrogen on safety and the conditions under which the risk in natural gas pipeline systems is acceptable for transporting hydrogen in natural gas.

- **Task 4.3: Leakage Assessment**

Review the gas leakage from the pipeline system and the effect that the addition of hydrogen might have on this leakage.

- **Task 4.4: Durability:**

Review the durability of pipeline materials under hydrogen service at the operating conditions and potential hydrogen levels to be introduced into the system. Identify potential concerns for pipeline safety and integrity from the impact of hydrogen on material durability.

- **Task 4.5: Integrity:**

Review the potential impact of hydrogen on pipeline integrity. Also review the suitability of current integrity management program (IMP) for hydrogen service and the maintenance cost under hydrogen service. The distribution system is the focus of this task. The current situation of integrity management for distribution pipelines and the issues that may arise with adding hydrogen in natural gas are addressed in the review.

- **Task 4.6: End use:**

Review the development of membranes for the efficient separation of hydrogen from a hydrogen/natural gas stream and the effect on the downstream gas quality after removal of hydrogen.

- **Task 4.7: Impacts:**

Review the environmental and macroeconomic benefits of using the existing natural gas network to transport hydrogen.

Overview – Natural Gas Distribution System in US

US Natural Gas Pipeline Infrastructure

The natural gas delivery pipeline infrastructure is divided into gathering, transmission, and distribution systems, see Figure 1. The distribution system consists of mains, service lines and meter set assemblies which comprise meters, regulators and other installations.

Transmission pipelines are typically linear systems that transport gas over a relatively long distance. These systems have relatively few connections on the main lines.

Distribution pipeline systems are arranged in a network to fit geographical configurations of the service area. There are many connections to the main lines. Networks can be designed in branch or tree configurations, be redundant or supplied by a single feed. Because of the interconnections, each section of pipe could receive its gas flow from more than one direction. A distribution system can be subdivided into pressure districts, where each district is operated at its own pressure level to ensure an adequate and reliable supply of gas to the area's customers.

Comparison of Transmission and Distribution Systems

Transmission pipelines traverse long distances and have few branch connections, predominately located in Class 1 and Class 2 locations as defined in 49 CFR Section 192.5. They are generally large diameter (up to 48") pipes and nearly 100% of the pipes are steel. Transmission pipelines typically operate at pressure levels between 600 psig (41.4 bar) and 1200 psig (82.7 bar), and in some cases up to 2000 psig (137.9 bar) and the stress levels mostly exceed 20% of the specified minimum yield strength (SMYS) of the steel pipes. Over 96% of the total transmission mileage is wrapped/coated steel pipe that is cathodically protected. Approximately 3% of the total transmission mileage is bare steel with and without cathodic protection. Failure of transmission pipelines usually occur as a catastrophic rupture of the pipeline, caused by the high pressure of the contained gas.

Distribution pipelines are generally small in diameter (as small as 5/8") and are constructed of several kinds of materials including a significant percentage of plastic pipes. Distribution pipelines also have frequent branch connections for service lines to individual customers. The dominant cause of distribution incidents is excavation damage with third party damage being the major contributor to these incidents. Distribution pipeline failures almost always involve leaks, rather than ruptures because the internal gas pressure is much lower than for transmission pipelines.

Both distribution and transmission facilities are subjected to a variety of periodic inspections mandated by 49 CFR Part 192, see Table 1. The requirements are similar for both transmission and distribution systems with some exceptions. Odorants are required for distribution pipelines and transmission pipelines in populated areas.

Piping Materials of Distribution Network

Department of Transportation (DOT) 2007 Annual Distribution Data shows the piping materials used to construct mains and service lines in distribution networks (Figure 2 and Table 2). The natural gas distribution system in the US includes 1,201,000 miles of distribution mains and 64,804,000 service lines. Steel and polyethylene plastic pipes are the dominant piping materials in distribution systems. The majority of the steel pipes in distribution mains and service lines are coated and cathodically protected.

Historically, distribution mains were primarily made of carbon steel pipe. Since the 1970s, a larger portion of the gas distribution main lines have been made of plastic, mostly polyethylene (PE) and sometimes polyvinyl chloride (PVC). PE pipes are increasingly being used to construct distribution pipelines and replace the aging iron and steel pipes in the low-pressure distribution system because of lower construction and maintenance costs.

As shown in Table 2 and Figure 2, distribution mains are almost evenly divided between steel and polyethylene pipes which account for 47% and 48% respectively. Typical steel grades for the main distribution pipeline include A, B, X42, and X46, see Table 3 for their material properties [10]. Cast iron (CI) and wrought iron (WI) pipes only accounts for 3% of the mains. Many of the cast iron systems were installed over fifty years ago when they were originally used to transport town gas. These lines have been operated for many decades at pressures from 0.25 psig (17.2 mbar) to 60 psig (4.1 bar). There is also a small amount of ductile iron (828 miles) and copper pipes (36.5 miles) used for distribution mains. In addition to polyethylene pipes, PVC and Acrylonitrile Butadiene Styrene (ABS) are the other two plastic pipes used in distribution mains, accounting for 1.8% and 0.2% respectively.

Distribution service lines are primarily made of polyethylene (63%) and steel (33%). The remainder consists of small percentages of copper (1.73%), cast and wrought iron (0.17%), PVC (0.4%), ABS (0.02%) and ductile iron pipes (0.001%). About 1.96% of the total service line pipes are not identified.

The sizes of the typical distribution pipes are between 1.5" and 8" for mains and 0.5" to 2" for service lines. The distribution of the pipe size for steel and PE pipes in distribution mains and service lines is plotted in Figure 3 and Figure 4 respectively. A small percentage of distribution mains and services have a larger diameter pipe, typically for commercial and industrial application.

Elastomeric Sealing Materials in Distribution Network

Elastomers have been used as mechanical coupling seals and gaskets, meter and regulator diaphragms, boots, O-rings, flange seals, valve seats, etc. There are many types of elastomers and the formulation varies with the application. Table 4 lists the type of elastomers that have been used in natural gas distribution systems. Butadiene-Styrene (SBR) and Butadiene-Acrylonitrile (NBR) are the two major elastomers that have been used as gasket, O-ring, diaphragms, flange and quad seals in natural gas industry.

Failure of elastomers could result in leaks. The major failure of elastomers comes from the chemical reaction between the elastomers and chemicals or the adsorption/permeation of the chemicals by the elastomers. This attack results in swelling and softening with a reduction of their tensile strength. The temperature and concentration of the chemical medium determines the degree of deterioration. The absorption and desorption of a gas medium during the change of gas compositions may result in permanent damage of the elastomers.

Some elastomers can be degraded in outdoor conditions when they are exposed to sunlight, ozone, and oxygen. This type of degradation can cause surface cracking, discoloration, significant loss of tensile strength, elongation and other rubbery properties.

Pure mechanical damage is not a frequent failure mode of elastomers. Most mechanical damage occurs as a result of chemical deterioration of the elastomer. When the elastomer is chemically deteriorated, it is more susceptible to mechanical damage. Elastomers become brittle when cooled below their glass transition temperature, and this can lead to brittle fracture of the elastomers.

Operating Pressure of Distribution Network

Distribution pipelines typically operate at pressures ranging from 0.25 psig (17.2 mbar, gas delivered directly to customers without any additional reduction in pressure) to 60 psig (4.1 bar) and sometimes up to 100 psig (6.9 bar). A few distribution pipelines operate at higher pressures of up to 400 psig (27.6 bar high pressure distribution pipelines). The stress levels of the steel pipes in distribution system are normally less than 10% of the ***Specified Minimum Yield Strength*** (SMYS).

Typical Failure Mechanism of Distribution Pipelines

Distribution pipeline incidents typically result in a leak instead of a rupture due to their relatively low operating pressures and the correspondingly lower operating stress. The primary safety concern is that if a leak goes undetected and the gas collects in a confined space, it can eventually ignite and causing an

explosion. The total numbers of the leak incidences in distribution systems from the DOT 2007 annual report are summarized in Table 5. The data are plotted as a function of failure mode in Figure 5 .

The exceptional case for distribution systems is “brittle-like cracking” in certain types of plastic pipe, which relates to crack initiation in the pipe wall, followed by stable crack growth, and eventual gas leak. Although significant cracking may occur at points of stress concentration, and near improperly designed or installed fittings, small brittle-like cracks may be difficult to detect until a significant amount of gas leaks out of the pipe and potentially migrates into an enclosed space. Premature brittle-like cracking requires relatively high localized stress intensification that may be the result of geometrical discontinuities, excessive bending, improper fitting assemblies, and/or dents and gouges.

Locations of Distribution Infrastructure Facilities

Distribution facilities are primarily located in populated areas. Distribution lines do not follow class locations, but the majority of the lines would fall into Class 3 and Class 4 locations under transmission class location definitions.

Distribution piping is frequently located in congested urban areas, typically under pavement in streets, highways and other public right-of-ways or utility easements.

Safety Records

The incident data in the Office of Pipeline Safety (OPS) database reported by operators for the period of 1990 through 2002 are summarized in Table 6 showing the causes of transmission and distribution incidents. During the period, there were a total of 957 transmission pipeline incidents and 1579 distribution incidents. The causes of incidents are classified into five major categories:

1. Corrosion
2. Outside Forces
 - First or second party damage;
 - Third party damage;
 - Earth movement (landslide/washout, subsidence, frost heave, earthquake, etc.);
 - Lightning or fire; and
 - Other
3. Construction Operating Error
4. Accidentally Caused by Operator
5. Other

Outside force is the predominant cause of incidents for transmission and distribution pipelines, but it is more significant in distribution (60.4% of total incidents and 46.6% of serious incidents) than for transmission (39.8% of total incidents and 36.9% of serious incidents). Corrosion is a much more significant cause in transmission pipelines (23.4%) than in distribution pipelines (3.7%). The other category is a significant cause in both transmission (22.3%) and distribution (23.9%) pipelines. No additional information is available to further determine the cause of these “other” incidents.

Figure 6 shows the serious incidents categorized by system part in the distribution systems reported to OPS from 1990 to 2002. Most of the serious incidents are associated with the mains, followed by services, meter set assemblies and a category termed “Other” and “No Data”.

The incident causes also vary with material of construction. Figure 7 shows the serious incidents categorized by construction materials in mains. The serious incidents in mains are primarily from polyethylene plastic pipes, steel, and cast iron pipes. These three materials are the most common pipe materials in distribution systems. Corrosion is an issue with steel systems, less so with cast iron and not at all with polyethylene. Third party damage is the dominant outside force category with all materials, but cast iron is subject to a higher proportion of incidents from earth movement.

The principal materials of construction for service lines are steel and polyethylene plastic. Other materials make up such a small percentage of the piping and are considered negligible. As shown in Figure 8, outside force is the largest cause of serious incidents in service lines, 54% and 76% for steel and polyethylene service lines respectively.

The dominant causes of failure for meter set assemblies are outside forces and “other”, with third party damage comprising most of the outside forces. No corrosion related serious incidents were reported for meter set assemblies during the study period from 1990 to 2002 [27].

Task 4.1 – Life Cycle Assessment

Hydrogen is considered an important energy carrier for a sustainable energy future. Developing a reliable hydrogen delivery system would remove one of the main economic barriers of a hydrogen economy. Pipeline transportation and distribution systems are cost effective ways to move hydrogen from its production location to its end users. There is a potential to transport hydrogen using the existing natural gas pipeline network. The potential benefits of adding hydrogen to natural gas have been addressed in the “NaturalHy Project-Work Package 1” through life cycle and socio-economic assessment.

This study was lead by *University of Loughborough*, and participants included by *COGEN Europe; ECN - the Energy Research Centre; Instituto de Soldadura e Qualidade (ISQ); Planungsgruppe Energie und Technik GbR (PLANET); SAVIKO Consultants ApS; and Technische Universität Berlin.*

Life Cycle and Socio-Economic Assessment Literature [1]

The complete life cycle consists of:

- The production of natural gas, related fuels, and hydrogen;
- The construction, operation, maintenance and decommissioning of relevant networks, and
- The utilization of natural gas, related fuels, natural gas/hydrogen mixtures and pure hydrogen.

The life cycle assessment concentrated on primary energy inputs relevant to energy resource depletion, green house gas emissions associated with global climate change, and other gaseous, liquid and solid emissions related to acidification, ozone depletion and eutrophication. Social-economic assessments address direct and indirect job creation, maintenance, and the internal economic costs.

A literature review was performed in this study to examine the existing work on relevant life cycle and socio-economic assessment. In total, 214 references were identified and 172 reviews were conducted. The coverage by technology and type of assessment is extremely diverse. Table 7 lists the technology areas in the literature database.

The references on employment are very limited. Most of the studies were completed during the 1970's and early 1980's and are currently considered outdated.

Standard Procedures for Life Cycle and Socio-Economic Assessment [2]

Standard procedures were established for calculating various environmental impacts, economic costs and employment implications of existing and possible future energy systems. The variables determined in the procedure for calculation include:

- Primary energy inputs as indicator of energy resource depletion;
- Greenhouse gas emissions associated with global climate change (carbon dioxide, methane and nitrous oxide);
- Pollutants affecting urban air quality (sulfur dioxide, oxides of nitrogen, and particulate);
- Internal economic costs; and
- Direct and indirect jobs in the European Union.

The calculations for the existing natural gas network were used as a baseline scenario for comparison against the intermediate scenario with addition of hydrogen:

1) Baseline Scenario

- Natural gas supply

- Natural gas network construction
- Natural gas network operation
- Natural gas network decommissioning

2) Intermediate Scenario

- Adjustment on gas leakage by adding of hydrogen
- Adjustment on Integrity Management Program for transporting hydrogen/natural gas mixture
- Hydrogen separation technologies
- Effect of hydrogen on end-user appliances
- Hydrogen production from different hydrogen generation technologies include:
 - Natural gas reforming without Carbon Capture and Storage (CCS);
 - Natural gas reforming with CCS;
 - Coal gasification with CCS;
 - Nuclear Power electrolysis;
 - Biomass; and
 - Wind power electrolysis.

Overall Benefits of Adding Hydrogen to Natural Gas [2]

The results from the calculation indicate some benefits of adding hydrogen to natural gas:

- 1) Significant reduction of greenhouse gas emissions if hydrogen is produced from biomass, wind power, and nuclear power
- 2) Some advantage on greenhouse gas emissions with hydrogen production from fossil fuels with CCS, but no benefits for decreasing primary energy demand or energy resource depletion
- 3) Potential benefits of selective extraction of hydrogen (this depends on the performance of the separation technology and the subsequent use of the hydrogen and the residual gas)
- 4) Potential benefits on improving air quality by reducing sulfur dioxide, oxides of nitrogen and particulate emissions if hydrogen is used in transportation and displaces conventional diesel fuel
- 5) Potential benefit on “greening” natural gas if the hydrogen/natural gas mixture is used directly in existing appliances for heat production and electricity generation

Summary on Life Cycle and Socio-Economic Assessment

The results from this study clearly support the beneficial effects on the environment from adding hydrogen to natural gas including the reduction of greenhouse emission and the improvement of air quality. However, the published work supported by this study addressed to a lesser degree the economic evaluation and employment aspects, and no concluding remarks were made.

Hydrogen has been acknowledged as an alternative energy carrier in US National Energy Policy, and is considered to be a substitute for petroleum-based fuels in light-duty transportation vehicles. A well-developed hydrogen economy will make use of the lowest cost sources of hydrogen, and central station natural gas and coal are the two lowest cost hydrogen sources, followed by various electrolysis-based systems. This could significantly reduce green house gas emissions if carbon capture and storage technologies are used. Large scale hydrogen production plants will likely be built in the future and a national hydrogen transmission and distribution system would be a cost effective way to distribute large volumes of hydrogen over long distances.

Currently, hydrogen is produced in a number of plants and is used primarily in the manufacture of chemicals and petroleum products. There are approximately 700 miles of hydrogen pipelines in US, which lie in the Gulf Coast region where large hydrogen refineries and chemical plants are concentrated. However, there are natural gas networks throughout the US. By utilizing the existing natural gas network for effective delivery of hydrogen in large volumes, there will be beneficial impacts on the society, economy, and environment.

Task 4.2 – Safety

The existing natural gas pipeline networks are designed, constructed and operated for conveying natural gas. The safety of the pipeline system and the risk posed to the public by the supply and use of natural gas are well understood and considered acceptable. Hydrogen has different chemical and physical properties which may adversely affect the risk presented to the public. The major concerns of the impact on safety, by adding hydrogen in the existing natural gas pipeline systems, include the potential rupture of pipeline by hydrogen and the increased probability of gas ignition, and the risk of fire and explosion hazards in an incidental leakage of a hydrogen/natural gas mixture.

GTI has reviewed the publications from NaturalHy Project and the Greenhouse Gas R&D Programme sponsored by International Energy Agency (IEA). The results from the above studies are used as a basis for ranking the severity of fire and explosion hazards in natural gas distribution systems at different hydrogen levels.

In addition, GTI performed a quantitative risk assessment based on the current US natural gas distribution system for conveying hydrogen containing natural gas. The risk factors for the existing distribution systems operated with natural gas was defined with: (a) the statistical data of the fatal incidents occurring in US distribution systems from 1990 to 2002 together with, (b) the survey results on the significant threats in distribution systems provided by utility operators. The overall risks for natural gas service are used as a baseline to compare the risks when hydrogen is added into natural gas distribution systems. The overall risk in distribution systems is assessed at three hydrogen levels that have been investigated in the NaturalHy project and other related research programs.

Risk Assessment by NaturalHy Project (Work Package 2) [3]

The potential risks of transporting hydrogen using the existing natural gas pipeline network have been investigated by “NaturalHy Project in Work Package 2”. This work was led by *Loughborough University*, and *Leeds University*, *CEA*, *Shell Hydrogen*, *UK HSE*, and *National Grid* participated also.

The risk is a combination of the likelihood and the consequence (hazard) of an incident. The data and results from NaturalHy Project Work Package 3 and 4 on the durability and integrity of natural gas pipeline for transporting hydrogen/natural blends were used to aid the re-evaluation of the failure frequency of pipelines under hydrogen services. Laboratory scale and large scale experiments were developed to examine the consequence of fire and explosion situations pertinent to hydrogen/natural gas mixtures. Simple and Computational Fluid Dynamic (CFD) models were developed and validated using the experimental data, and the models were used to assess the impact of different level of hydrogen on the severity of the hazards which may arise from a wide range of accident scenarios.

The Impact on the Likelihood of Incident by Adding Hydrogen:

Failure frequency of pipelines is unchanged compared to that of natural gas pipelines with up to 50% hydrogen addition when an appropriate integrity management system is in place. The ignition probability is higher for hydrogen and natural gas mixtures due to the significant reduction in the minimum energy required for ignition and the increase in the upper flammability limit.

The Impact on the Consequence of an Incident by Adding Hydrogen:

The gas buildup behavior is similar in nature to natural gas. The concentration of the gas buildup is slightly higher with hydrogen addition of up to 50% in natural gas, but gas build up concentration significantly increase at hydrogen level above 50%, especially when the hydrogen addition is larger than 70%.

In a vented explosion, 20% hydrogen addition made little difference on the explosion severity, but 50% or higher hydrogen additions will increase the severity.

In an event of gas buildup in a confined space, the explosion severity increases moderately up to 30% hydrogen addition, but it significantly increases for 40% or more hydrogen addition. Fire hazard slightly decreases with hydrogen addition.

Risk Assessment:

A risk assessment tool (LURAP) was produced, based on the analysis of likelihood and consequence, to calculate the risk at different levels of hydrogen in natural gas. It was found that adding hydrogen in the natural gas pipeline increases the risk to an individual at location near the pipeline, but decreases the extent of the hazardous region.

In addition, the risk assessment of the expected background level leakage from the pipeline network indicates that the level of leakage overall is very small and poses no hazard from a safety standpoint.

Overall Safety Effect by Adding Hydrogen to Natural Gas Network (Greenhouse Gas Programme, IEA [11])

The potential change of gas properties by adding hydrogen up to 25% in natural gas and the resulting impact on the hazards have been assessed relative to the use of standard natural gases in this study, and the results are summarized in Table 8. Based on this assessment, adding hydrogen up to 25% increases the explosion risk in a confined room and the probability of a fire. It is concluded in this study that the use of hydrogen blended natural gas under well regulated circumstances should not increase the risk of explosions in comparison to those with unblended natural gas.

Risk Assessment for US Natural Gas Distribution Systems under Hydrogen Service

The potential risks posed to the public by natural gas distribution pipelines are generally assessed by the probability of pipeline failure and the consequence of the failure, i.e.:

$$Risk = Probability * Severity \quad (1)$$

The major failure mode in natural gas distribution pipelines is by leak, and the statistical data published by DOT in the 2007 annual report are categorized into eight failure modes for the leak incidences (see Table 5):

1) Corrosion

Leak resulted from corrosion is one of the failure modes in distribution system. It includes the external corrosion from bare steel pipes, coated/wrapped steel pipes and cast iron pipes, and internal corrosion. The leak from corrosion defects in distribution system can result in the gas buildup in a confined area and create a hazard of fire or explosion.

2) Material Defect

Manufacture related defects are one type of material defects for pipes. These include defective materials, pipe, pipe seam or piping components, etc. The other type of defects are related to construction, such as defective pipe girth welds, defective fabrication welds, stripped threads, broken pipes or couplings for steel pipe, and defective fusion, installation error, and improper back fill for plastic pipes.

This type of failure can result in slow release of gas and will pose fire or explosion hazard if the leak occurs in a confined space.

3) Natural Force

Natural force includes the forces that are applied to the pipeline from earth movement in the event of landslide/washout, subsidence, frost heave, earthquakes, etc. Natural force can result in severe damage of the pipeline and significant release of gas.

4) Excavation Damage

This is the damage of pipes during excavation which normally result in a leak or in rupture of the pipeline.

5) Other Outside Force

This is the damage from the outside force other than natural force or excavation.

6) Equipment Malfunction

This failure results from equipment malfunction, such as gasket or O-ring failure, control/relief equipment malfunction, seal failure, piping component failure, etc.

7) Operation

This is the failure from incorrect operations, e.g., the operator doesn't follow correct operational procedure.

8) Other

This includes the failure modes that don't fall into any of the above categories.

Table 5 and Figure 5 show the percentage of the leak incidents from each failure mode in distribution mains and service lines. Corrosion and excavation are the two frequent leak incidents. In view of adding hydrogen into the distribution system, the likelihood of each failure mode will not be significantly changed. However, the possibility and severity of a fire or explosion can be increased by the presence of hydrogen in natural gas.

The hazards of fire or explosion in natural gas distribution systems are ranked into six levels (no hazard (0), minor (10), minor to moderate (20), moderate (30), moderate to severe (40) and severe (50)) based on the risks posed to the public by pipeline failure, see Table 9. For each category of pipe materials in distribution main and service lines, the hazards are assessed on the eight failure modes based on the incident data from OPS database and the survey results on the significance of the threats in natural gas distribution pipelines provided by utility operators (see Task 4.5) [27].

The risk factors for the five material categories are defined using the ranking in Table 9 for each failure mode and shown in Table 10 and Table 11 for distribution mains and service lines respectively. The last column in Table 10 and Table 11 is the overall risk factors for each failure mode presented by natural gas, and it is calculated by the sum of the risk factor of each type of material times the percentage of this type of material in the system, i.e.:

$$RF_{Overall} = \sum_{(i=1 \text{ to } 5)} [RF_i * P_i] \quad (2)$$

$RF_{overall}$: the overall risk factor

RF_i : risk factor for each material category (total of five categories)

P_i : percentage of each type of material in distribution mains or service lines

The overall risks for each failure mode in Table 10 and Table 11 are further assessed for hydrogen/natural gas mixture at three hydrogen levels (< 20%, 20 to 50% and > 50%). These three levels

are identified based on the studies in NaturalHy and other literature sources that have investigated the influence of hydrogen concentration on the occurrence of fire or explosion by hydrogen/natural gas mixtures and the severity of the hazards.

In distribution mains, most of the pipelines are considered as in the vented condition. Adding hydrogen in the natural gas will increase the gas buildup near the pipeline, but the change of gas buildup behavior is slight for hydrogen up to 50%. The hazard resulted from slow release of gas, such as the gas leak from corrosion or manufacture defects are not significantly increased by adding up to 20% hydrogen in natural gas, but it will be significantly increased at higher hydrogen level, especially above 50% hydrogen. In the case of pipeline failure by outside forces such as excavation damage or natural force, the explosion hazard is increased with the presence of hydrogen, and the risk factor is significantly increased at hydrogen level above 50%. Table 12 and Table 13 show the influence of hydrogen on the risk factor (for mains and services respectively) of each failure mode and the overall risks at the three levels of hydrogen concentration. The overall risk calculated using Equation (1) indicates that the overall risk in distribution mains is increased by adding hydrogen in natural gas. The increase of the risk is moderate by adding up to 50% hydrogen, but the increase becomes significant when more than 50% hydrogen is added.

On the contrary to distribution mains, many of the pipelines in distribution services are in the confined space, such as within the building area. The leaked gas cannot be vented quickly and the gas buildup in the confined space will increase the possibility of a fire or explosion. Adding hydrogen in natural gas increases the risk factors for all the failure modes in service pipelines. The overall risk is significantly increased at all hydrogen levels, and it becomes severe at hydrogen levels above 20% as shown in Table 13.

Summary and GTI's Concluding Remarks on Safety

GTI performed a quantitative risk assessment on US natural gas distribution systems for carrying hydrogen containing natural gas. The risk analysis is based on the research findings from NaturalHy and other studies related to the influence of hydrogen on the potential risks posed to the public by transporting hydrogen in the existing natural gas network. The statistical data of the fatal incidents occurring in US distribution systems from 1990 to 2002 together with the survey results on the significant threats in distribution systems were used to define the baseline risk factor for each failure mode under natural gas service. The influence of hydrogen were assessed based on the research findings from NaturalHy and other studies, and the risk factors defined for each failure mode at three hydrogen levels that have been investigated in the literature.

Compared to the current situation with natural gas, the risks present in natural gas distribution systems are increased by adding hydrogen into the system. The impact depends on the hydrogen concentration in the gas mixtures. If less than 20% hydrogen is introduced into distribution system, the overall risk is not significant. But the service lines are more critical than distribution mains because they are mostly installed in the confined spaces. In this case, adding hydrogen in the gas increases the explosion risk in the event of a gas leak. If the hydrogen level in natural gas increases beyond 20%, the overall risk in service lines can significantly increase and the potential hazards can become severe, while the overall risk in distribution mains still can be moderate up to 50%. For hydrogen level above 50% in natural gas, the risks in both distribution mains and service lines significantly increase compared to the situation with natural gas, and the overall risk in distribution system becomes unacceptable.

Task 4.3 – Leakage Assessment

Because of the smaller molecular size of hydrogen, the leakage rate of hydrogen through pipe wall and joints may be larger than methane, and result in economic and safety concern of the total loss of gas. GTI has reviewed the publications from NaturalHy Project which mainly focus on the permeability of plastic pipe materials including polyethylene (PE) and polyvinyl chloride (PVC). GTI also reviewed the report from IEA Greenhouse Gas R&D Programme and other relevant information for gas leakage in the natural gas distribution pipeline under hydrogen services.

Assessment of Permeation Loss by NaturalHy Project (Work Package 3) [3, 18]

Permeation loss of gas from plastic pipes has been investigated by “NaturalHy Project in Work Package 3”. This work was performed by Gaz de France. In this investigation, real pipes and assemblies were tested at the operating temperatures and pressures with hydrogen/methane mixture in order to more precisely evaluate the permeation of hydrogen through the plastic pipe in the natural gas distribution network.

Three different PE grades (PE 63, PE 80, and PE 100) in the diameter range from 20 mm (0.79") to 200 mm (7.87") with pressure between 14.5 psig (1 bar) and 174 psig (12 bars) or over and temperatures in the range from 5°C to 25°C. These represent commonly used polyethylene materials and pipe sizes in the natural gas networks and typical operating conditions. Pure methane and hydrogen/methane mixture containing 10% hydrogen were used in the tests to investigate the permeation behavior of hydrogen/natural gas mixture compared to natural gas. Table 14 shows the permeation coefficient of hydrogen and methane from a test under 58 psig (4 bar), 116 psig (8 bar) and 174 psig (12 bar) with a 32 mm (1.26") PE 80 pipe. The calculated gas loss based on the experimental data at the test pressures is also included in this table. The results from this study are summarized in the follow [18]:

- There is an incubation time for methane to diffuse through the pipe, while the incubation time for hydrogen is close to zero.
- The permeation rate of methane and hydrogen increases with the increase of the internal pressure.
- The permeation coefficient of hydrogen is 4 to 5 times greater than that of methane in the hydrogen/methane mixture, even if the hydrogen partial pressure is lower by an order of magnitude than that of methane in the mixture.
- The absolute values of methane loss calculated for three type of PE piping materials are far lower than the extrapolated data.
- The aging of the pipes seems to have no significant influence on the permeation coefficients in these experimental conditions.

One type of PVC (PVC-CPE) was also included in this study, and the calculated hydrogen leakage rate from PE and PVC pipes at 2.9 psig (200 mbar) distributing 100% H₂ are [8]:

- PE100: 5.0 liter/km/day, and
- PVC: 13.2 liter/km/day

The leakage rate of methane and hydrogen calculated from PE disc samples under a mixture of 80% natural gas and 20% hydrogen at 58 psig (4 bar) are [8]:

- Methane: 1.1 liter/km/day, and
- Hydrogen: 2.3 liter/km/day

Additional Information on Leakage Assessment

In addition to the gas leakage study in NaturalHy project, GTI also reviewed the report from IEA Greenhouse Gas R&D Programme [11] and other relevant information [13, 18, 19, 29] about hydrogen leakage in natural gas distribution systems.

Gas Leakage from Steel or Ductile Iron Systems [19]:

The leakage in steel and ductile iron systems mainly passes through the threads or the mechanical joints. The leakage measurements carried out by GTI on gas distribution systems indicated that the volume leakage rate for hydrogen is about a factor of three higher than for natural gas.

Gas Leakage from Plastic Pipes and Elastomers [11, 13, AGA handbook]

Leakage Assessment by IEA Greenhouse Gas Programme [11]

The permeation coefficient of hydrogen in several plastic pipes was determined by experimental measurements in this study. The experimental data and the literature data are summarized in Table 15 [11]. A calculation of the total loss of hydrogen was performed in this study based on the experimental data of a representative material from the Dutch grid. The estimated gas loss is $26 \times 10^3 \text{ m}^3$ (918,182 Ft³) per year when 17% hydrogen is added into this gas distribution system. This amount of gas loss only represents 0.0005% of the hydrogen transported. Thus the gas loss due to the hydrogen permeation is considered as negligible and will not create a significant problem.

Estimation of Gas Loss for US Distribution Network

The majority of the plastic pipes used in US natural gas distribution systems are polyethylene pipes including medium density polyethylene (MDPE) and high density polyethylene (HDPE). There are also small percentage polyvinylchloride pipes. These materials are similar to those used in European natural gas distribution system, but with different material designation system.

The permeation coefficient of hydrogen and methane in the typical plastic pipe and elastomeric materials that have been used in US distribution systems are summarized in Table 16 [13, 29]. The hydrogen permeation coefficient in the US grade plastic pipe materials are very close to those published by IEA's study [11]. It appears the permeation coefficient of hydrogen is about 5 to 6 times of that of methane in the plastic pipes. The hydrogen permeation coefficient is even higher in elastomers, especially in natural rubber and Buna S, which are 26 and 21 times of that in HDPE.

Because the plastic pipes have much larger surface area than the seals, the gas leakage rate is calculated with plastic pipes to estimate the amount of gas leakage in the entire gas distribution system. The gas leakage rate (V) through plastic pipes can be calculated using the permeation coefficient (P) [30]:

$$V = P \cdot (A/t) \cdot \Delta p \quad (3)$$

A: the surface area of pipe

t: pipe wall thickness

Δp : the pressure difference between internal and external surface of pipe

High density polyethylene is used as an example for this calculation with a pipe diameter of 1" and wall thickness of 0.1" which is a representative pipe dimension in the distribution system. Table 17 shows the calculated hydrogen and methane leakage rate at the typical distribution operating pressures (60 psig (4.1 bar), 3 psig (210 mbar), and 0.25 psig (17.2 mbar)) with various hydrogen concentrations of hydrogen/methane mixtures. The gas leakage data are also plotted vs. the hydrogen content at the operating pressures in Figure 9. The total volume of gas loss of hydrogen and natural gas increases by adding hydrogen due to the higher permeation rate of hydrogen. The total gas loss from a gas mixture

containing 20% hydrogen is about double the gas loss from a pure methane, but the amount of gas loss with this hydrogen content from a 1" HDPE pipe at low pressure (3 psig (210 mbar) and 0.25 psig (17.2 mbar)) is not significant (5.3 ft³/mile/year and 0.4 ft³/mile/year at 3 psig and 0.25 psig respectively).

Since the service lines normally operate at 3 psig (210 mbar) or 0.25 psig (17.2 mbar), the total gas loss from service lines is negligible compared to that from distribution mains which operate at 60 psig (4.1 bar) or higher. The estimated total gas loss in the distribution systems at different hydrogen levels in the gas mixture is shown in Figure 10 using 60 psig (4.1 bar) as a representative operating pressure and the mileage for PE pipes with the size less than 2" diameter which accounts about 69% of the total plastic pipes in distribution system. The gas leakage rates obtained from experimental measurements in NaturalHy are also included in this plot. For pure methane, the gas loss calculated from NaturalHy experimental data is close to the calculation from AGA handbook. However, for the gas mixture containing 10% hydrogen, the gas loss calculated based on NaturalHy experimental data is only half of that based on the permeation coefficient from AGA handbook. The total gas loss for the gas mixture containing 20% hydrogen is about 40 million cubic feet per year, and it is about double the total gas loss from pure methane, but this amount is still not significant from the economy point of view.

Summary and GTI's Concluding Remarks on Gas Leakage

It has been indicated by the research studies and literature data that hydrogen is more mobile than methane in many polymer materials including the plastic pipes and elastomeric seals used in natural gas distribution systems. There is almost zero lag time for hydrogen to penetrate the pipe wall, and the permeation rate of hydrogen is 4 to 5 times faster than methane through the typical pipes used in natural gas distribution.

The permeation coefficient of hydrogen is even higher through most of the elastomeric sealing materials that are used in natural gas distribution systems. Natural rubber and Buna S (SBR) have less sealing ability to hydrogen compared to the other elastomers.

Since plastic pipes have much larger surface area compared to the seals, a typical polyethylene pipe used in natural gas distribution system is used to estimate the gas loss through pipe wall at the general operating pressures. The calculation based on the literature data of the permeation coefficient of hydrogen and methane in the polyethylene pipe (PE 3608 or PE 4710) indicates that the majority of the gas loss is from the pipes in distribution mains which operate at 60 psig (4.1 bar) or higher. The gas loss from the total of 414,830 mile polyethylene pipes with the size less than 2" in the entire distribution mains is about 40 million cubic feet per year if 20% hydrogen is added into natural gas pipeline system. Though this amount of gas loss is almost double the total gas loss when the systems deliver only natural gas, it is still considered insignificant from the economic point of view. In addition, adding hydrogen in natural gas can slightly reduce the leakage of methane into the environment which is beneficial for greenhouse gas reduction.

The hydrogen permeation coefficient from literature data is higher than that from the experimental measurements in NaturalHy project, especially at lower pressure. This phenomenon is reasonable because the literature data is measured in pure hydrogen and thin polymer films. It is most likely that hydrogen is less mobile in a low concentration hydrogen/methane mixture because the activity of hydrogen is much lower compared to pure hydrogen. Further, the plastic pipe has a much thicker wall and denser structure than the thin film which will increase the resistance for hydrogen to penetrate. Thus, the gas loss based on literature data may over estimate the gas loss from a pipeline system containing low concentration of hydrogen, especially at low operating pressures, e.g. 3 psig (210 mbar) or 0.25 psig (17.2 mbar). In order to obtain a more accurate estimation of the gas loss in the distribution system, it is necessary to perform further investigations testing pipes under general distribution operating pressures and at hydrogen concentrations that are typical of what will be used for blending hydrogen into natural gas pipeline systems.

The amount of gas loss from service lines is negligible from the economic point of view, but gas leaking in a confined space may increase hydrogen concentrations to levels that may become a threat from the safety standpoint. This is the same for elastomeric seals which have higher permeation rates for hydrogen. The accumulation of leaked gas over time may present a safety concern in a confined space where there are many sealed joints. This issue has not been well studied in NaturalHy and the other investigations, and remains a gap for the risk assessment.

It is important to obtain further understanding on hydrogen permeation behavior in plastic pipes and elastomeric materials under the expected operating conditions for hydrogen services. Further investigation should be performed on the existing pipe and seal materials as well as newly developed materials that can be used as a replacement for current materials. This will provide a basis to accurately estimate the gas leakage through pipes and seals, and in particular to determine if the leakage in a confined space over time will present a safety risk and if it is required to implement a leak detection/monitoring device.

Task 4.4 – Durability

It is well known that hydrogen damage is one of the concerns for many metallic piping materials. The occurrence and the severity of hydrogen damage on metallic materials depend on the type of materials, hydrogen concentration and the operating parameters. It is crucial to understand the acceptable hydrogen level that can be blended into natural gas without negatively impacting the lifetime of the infrastructure.

Since hydrogen is the smallest element, it has a greater tendency than natural gas to leak through valves, seals, gaskets and pipes. The accumulation of hydrogen in a confined space may create safety concerns. Gas meters record the volumetric quantities of the gas supplied. Adding hydrogen into natural gas changes the gas properties. Therefore, it is necessary to quantify the deviation of the gas meter when measuring hydrogen/natural gas mixtures at various hydrogen levels.

The above issues relate to material degradation. Leakage and meter accuracy were investigated in the NaturalHy Project-Work Package 3. The aim of this investigation was to develop sufficient knowledge for establishing hydrogen level in the blends, estimating the lifetime for different natural gas networks, identifying and removing bottlenecks for transporting hydrogen in the natural gas network and developing operational guidelines. The goal of the NaturalHy Project is to determine the feasible conditions under which hydrogen produced from a centralized production site can be injected into high pressure transmission pipelines and deliver to end users through distribution networks. Under this scenario, the durability of pipeline materials in distribution network is less of a concern than transmission pipelines because distribution pipelines operate at much lower pressure levels. Thus, hydrogen degradation of metallic components in natural gas distribution systems was not studied in the NaturalHy Project based on the hypothesis that the integrity of metallic components in low pressure distribution systems will not be significantly impacted at the hydrogen levels that are acceptable for high pressure transmission pipe.

In view of the long term goal of the US to use hydrogen as a sustainable energy carrier, hydrogen produced from the satellite, local production sites, will play a role in the hydrogen economy, especially in utilizing renewable energy such as wind and solar. In this scenario, hydrogen is most likely to be blended into natural gas distribution networks directly and the hydrogen level in natural gas determined from the pipeline materials and operating conditions for transmission pipelines could be conservative. A beneficial improvement can be made on the productivity of hydrogen delivery and recovery of hydrogen from gas mixture at end users if higher levels of hydrogen can be injected directly into natural gas distribution systems without adversely impacting pipeline integrity.

In order to provide a comprehensive point of view on the impact from hydrogen on distribution pipeline materials, GTI included other literature sources on materials degradation, hydrogen leakage and gas meter accuracy with hydrogen/natural gas. In addition, GTI performed a thorough review of the pipeline materials using the distribution pipeline data published by DOT and the GTI literature sources. By integrating the literature information with the pipeline materials and operating conditions in the natural gas distribution system, GTI assessed the durability of the US natural gas distribution infrastructure for transporting hydrogen/natural gas mixtures.

Durability (NaturalHy Projects-Work Package 3) [8, 17, 18]

This investigation was led by GDF SUEZ, with participation by Commissariat à l’Energie Atomique, CMI, CSM, DBI-GUT, DEPA, Ecole Nationale des Ingénieurs de Metz, GASUNIE, Institut Français du Pétrole, IGDAS, ISQ, STATOIL, TNO, TOTAL and TUBITAK.

In this project, the effects of hydrogen on the durability of the materials and components used in the natural gas transmission and distribution network, as well as the end user devices were studied.

Hydrogen Affect on the Initiation and Growth of Defects in Transmission Pipelines

This work focused on the hydrogen embrittlement of steel pipes used for high pressure natural gas transmission pipeline, and the crack growth from the existing defects, such as corrosion defects and sharp defects in the welds. It is concluded in this study that adding up to 50% hydrogen into the natural gas transmission pipelines may not cause catastrophic failure. The acceptable hydrogen level depends on the type of steel used for high pressure pipeline.

Because distribution system operate at much lower pressure than transmission pipeline and are built with lower grade steels, no additional studies were performed in NaturalHy to evaluate the risk of hydrogen embrittlement on distribution steel and other metallic pipes. Additional review and evaluation by GTI on the integrity impact from adding hydrogen on distribution pipes are included in the next section.

Hydrogen Permeation in Plastic Pipes in Distribution Network

This work has been reviewed in Task 4.3, and the main conclusion is that permeation of hydrogen through the walls of PE pipes is 4-5 times faster than methane. Nonetheless, the gas permeation loss is still very small and acceptable from a safety, economy and environmental point of view.

Aging of Plastic Pipes in Hydrogen/Natural Gas Blends

Aging of PE pipe materials was tested with laboratory samples and it was concluded that aging effect of hydrogen on PE pipe materials is not significant. But aging of the other polymer materials such as PVC, ABS and the elastomeric sealing materials was not reported in this study.

The Reliability of Gas Meters for Hydrogen Services

Three gas meters with polymer membranes manufactured by Gallus (France), Dresser (Italy) and Elster (Germany) were tested with two gas mixtures (100% methane and 50% hydrogen and 50% methane). The test results on Dresser meter show a positive change, while the test results on Gallus and Elster meters show a negative change in 50% hydrogen/methane mixture compared to 100% methane. But the gaps are less than 2% for all the tested meters and they all decreases at lower flow rate.

Additional Information for the Durability of Pipeline Materials under Hydrogen Services

In addition to the durability studies published by the NaturalHy Project, GTI include additional literature sources related to the effect from hydrogen on pipeline materials and equipments. They are used as supplemental information to provide a comprehensive point of view in terms of the impact from hydrogen on the distribution systems and the basis to assess the potential risks imposed to the system in the presence of different levels of hydrogen in natural gas.

Hydrogen Damage of Metals

Hydrogen damage is a form of environmentally assisted failure that results most often from the combined action of hydrogen and residual or applied tensile stress. The failure includes cracking, blistering, hydride formation and loss in tensile ductility and it has been generally called hydrogen embrittlement (ASM Vol. 13a). In general, the hydrogen damage occurs at a stress level below those typically experienced for a particular metal in an environment without hydrogen. It is affected by hydrogen pressure, purity, temperature, stress level, strain rate, and material microstructure and strength.

The specific types of hydrogen damage have been categorized in *ASM Handbook Vol. 13A*, see Table 18. This table includes the materials that are susceptible to hydrogen damage, the various types of hydrogen damage, the source of hydrogen and the typical conditions for the occurrence of failure. The first three classes are grouped together and designated hydrogen embrittlement. It appears that the conditions for hydrogen damage on iron or copper do not apply to natural gas distribution system, thus there should be no concern of hydrogen damage on iron and copper pipes in the distribution system. Though hydrogen embrittlement is a potential concern for steel pipe, this effect varies with the steels. In

general, high-strength steel (>100 ksi yield strength) are more susceptible to hydrogen induced cracking, while low-strength steel is only subjected to loss in tensile ductility.

Hydrogen Impact on Steel Linepipe

Hydrogen Embrittlement of Steel Pipe [11]

Many steels are prone to hydrogen embrittlement, which is the type of brittle fracture at a sustained load below the yield strength when materials are exposed to hydrogen. High pressure transmission steel pipeline is more of a concern due to the higher stress from the operating pressure and the higher strength of pipeline material, especially the new natural gas pipeline construction. Hydrogen concentration and operating pressure are the most critical factors to cause hydrogen embrittlement.

The steel grades (API 5L A, B, X42 and X46) used in natural gas distribution pipeline are relatively low strength steels. The predominant hydrogen damage for low strength steels is loss of tensile ductility or blistering, but they usually fail in a ductile mode instead of catastrophic brittle fracture in hydrogen environment. The severity of the hydrogen damage depends significantly on the hydrogen concentration and operating pressure.

Hydrogen Assisted Fatigue [13]

Carbon and low alloy steels show accelerated fatigue crack growth and degradation in fatigue endurance limits when expose to hydrogen even at relatively low pressures. The accelerated fatigue crack growth is more pronounced at ambient temperatures and becomes less severe at elevated temperatures. The presence of hydrogen reduces the threshold cyclic stress intensity factor (ΔK_{th}) as well as fatigue life, thus fatigue cracking will be a concern if the pipeline experiences pressure fluctuations.

Enhanced Crack Growth on Existing Defects [11]

Crack growth from existing defects may be enhanced by the addition of hydrogen due to the reduced ductility of steel, and fluctuation of the operating pressure in the pipeline may accelerate this effect.

At low and medium pressures (< 290 psig (20 bar)) in distribution systems, the pipeline will be far less susceptible to hydrogen enhanced crack growth due to the relatively low operating tensile strength compared to the design strength. There is a long history of the successful transportation of “pure” hydrogen at pressures below 290 psig (20 bar) across the world, no operational problems occurring over many decades. Town gas, which contains hydrogen, also has been transported historically in gas distribution pipelines.

Welding Requirements for Hydrogen Services [13]

The welds should be defect free and the weld heat affected zones must match the mechanical and toughness properties of the linepipe. The hardness levels in the weld and weld heat affected zone must be controlled to avoid hard spots to ensure the adequate toughness for hydrogen containing environment.

Hydrogen Impact on Non-Metallic Materials

Compatibility of Polymer Materials with Hydrogen [13]

The degradation of polymer materials in normal environmental conditions includes UV irradiation, chemical attack and thermal breakdown. With respect to the investigation of the polyethylene pipeline for hydrogen service, no degradation by pure hydrogen has been reported. Little or no interaction between hydrogen gas (or any non-polar gas) and polyethylene should be expected [30]. In addition, hydrogen alone does not provide radicals that can cause polymer breakdown. Most of the elastomers are also compatible with hydrogen. Table 19 lists the major plastic and elastomeric materials used in natural gas pipeline and their compatibility to hydrogen.

Though pure hydrogen dose not promote the degradation of polymer materials, some contaminants in

hydrogen gas may be harmful to pipeline materials, and the degradation depends on their concentration.

Hydrogen Permeability in Plastics [11]

This has been reviewed in Task 4.3. In plastic pipe systems, hydrogen diffuses faster than methane through the plastic pipe wall, but the total loss of hydrogen is considered insignificant from the economic standpoint.

Impact of Hydrogen on the Durability of Gas Meters [11]

The influence of hydrogen addition was measured for leather and plastic diaphragm gas meters in Polman's study [11]. The deviations in gas metering were determined with natural gas and 17% hydrogen/natural gas mixture at five different flows from 0.013 to 5 m³/h. For the two types of gas meters, the deviations observed were lower than 0.1%. This deviation can be regarded as negligible considering the calibration standards stating a maximum deviation of 4% for recalibration and repeatability within 0.2%.

This study also examined the required capacity of gas meters for measuring hydrogen/natural gas mixtures. The results indicated that for mixtures up to 17%, the required capacity is not affected by adding hydrogen in natural gas.

It is concluded in this study that the gas meters used in natural gas distribution systems are not expected to be changed.

Summary and GTI's Concluding Remarks on Durability

Impact of Hydrogen on the Durability of Metallic Pipes in Distribution Systems

The metallic pipes in US distribution systems are primarily made of relatively low strength steel, typically API 5L A, B, X42 and X46 in distribution mains. The major hydrogen damage of these steels in a hydrogen containing environment is loss of tensile strength or blistering which strongly depends on the hydrogen content in the environment. They normally fail in ductile mode, and are not the type of steels that are susceptible to hydrogen induced brittle cracking.

In addition, the operating pressure in distribution system is normally less than 250 psig (17.2 bar), and the stress level in most of the steel pipes, generated by operating pressure, is less than 20% SMYS. Under this stress level, the potential risks for the low strength steel pipes in distribution system are low considering the failures by hydrogen (hydrogen induced stress cracking, hydrogen enhanced fatigue cracking or hydrogen enhanced crack growth from the existing defects) which are the major integrity concerns for high pressure transmission pipelines transporting hydrogen.

For the other metallic pipes, including ductile iron, cast and wrought iron, and copper pipes, there is no concern of hydrogen damage under general operating conditions in natural gas distribution systems.

Impact of Hydrogen on the Durability of Plastic Pipes and Elastomers in Distribution Systems

There is no major concern on the hydrogen aging effect on PE or PVC pipe materials. Most of the elastomeric materials used in distribution system are also compatible with hydrogen. There is very small amount of ABS pipes in distribution mains (0.2%) and service lines (0.02%). No investigation on the aging and permeability of this pipe material has been performed. Since this material only takes very small portion in the distribution pipes, and also it is not the pipe material to be used for new construction, the unknown performance from ABS will not significantly affect the overall performance for the plastic pipes in distribution system. If ABS is of direct concern, targeted testing could be conducted. Therefore, it can be concluded that material aging by hydrogen is not a major concern on the durability of the polymer materials in natural gas distribution systems.

One remaining durability gap that needs to be addressed is the potential contaminants in hydrogen gas that may be introduced into the network. The specification for the purity level of the hydrogen gas to be transported by natural gas pipelines has not been determined.

Impact of Hydrogen on the Durability of Gas Meters

The deviation of a gas meter with hydrogen/methane mixtures varies with the manufacture's detail of the meter design, e.g., Dresser meter show a positive change while those from Gallus and Elser show a negative change. Nonetheless, the deviation is acceptable based on the requirement for recalibration (<4%) when they are measuring a gas mixture containing less than 50% hydrogen. The meters may not need to be "tuned" under the potential hydrogen levels (<50%) in natural gas pipeline that are transporting hydrogen/natural gas mixtures.

Task 4.5 - Integrity

There are always existing defects in the pipe materials or welds. The current integrity management for natural gas pipeline systems is based on the operating conditions for transporting natural gas. Adding hydrogen into the pipeline network changes the pipeline operating environment, which may accelerate crack propagation or fatigue failures from the existing defects, and thus adversely impacts pipeline integrity. There may be certain defects which are acceptable under current integrity management criteria which will become critical due to the material property change in hydrogen containing environments.

In the US, the Pipeline and Hazardous Materials Safety Administration (PHMSA) has implemented integrity management requirements for hazardous liquid and gas transmission pipelines, but no similar requirements currently exist for gas distribution pipelines. In 2009, PHMSA published the final rule effective on Feb. 12, 2010 to establish integrity management requirements for gas distribution pipeline systems. The operators are given until August. 2, 2011 to write and implement the integrity program for distribution pipeline systems.

The investigations of the suitability of current integrity programs for hydrogen services have been focused on the natural gas transmission pipelines. The integrity concern in the medium to low pressure distribution system is considered a lower risk compared to high pressure transmission pipeline assuming that the hydrogen level that is acceptable to high pressure transmission pipeline will not create a significant threat to distribution systems which operate at much lower pressures.

Because the natural gas distribution systems are different from transmission pipelines and they are constructed with a large variety of materials and operated with varied pressures and other conditions, it is not appropriate to simply apply the integrity program for transmission pipelines to distribution systems. In order to assess the potential risks of adding hydrogen to the distribution systems, GTI performed a review on the natural gas distribution systems (see the section “**Overview-Natural Gas Distribution System in US**”) and the potential fourteen threats in the distribution systems which have been identified by the **American Gas Foundation** through the survey of a group of utility operators [27]. Each of the threats has been reevaluated by GTI for the conditions under which the systems transport hydrogen/natural gas mixtures. The integrity investigation from the NaturalHy Project is used as a basis to identify the risk to the integrity of distribution systems.

Integrity Management Program for Transporting Hydrogen/Natural Gas Mixtures [4,5,6]

The needs to upgrade current Integrity Management Program (IMP) for transporting hydrogen/natural gas mixtures were investigated in “NaturalHy Project Work Package 4”. The aim of this project is to provide a specification for an Integrity Management Tool (IMT) that allows the operator to modify the existing IMP for hydrogen service. The cost of the new IMP was also evaluated in this study.

This work was led by *DBI-GUT*, with participation by *TNO Science & Industry*, *Computational Mechanics BEASY*, *GDF SUEZ*, *PII Ltd.*, *Istanbul Gas Distribution Co. Inc. (IGDAS)*, *N.V. Nederlandse Gasunie*, *Instituto de Soldadura e Qualidade (ISQ)*, *Turkish Scientific and Technical Research Council (TUBITAK)*, *StatoilHydro* and *Total*.

Defects in Natural Gas Pipeline Systems and the Potential Impact by Hydrogen

The acceptable defects in the natural gas pipeline systems are defined in the current integrity program by the number, type, distribution and the shape of the defects. The aspects to be concerned with for hydrogen services is the stress generated at a defect and the rate at which the defect can propagate if the stress is over the critical value for crack propagation. Blunt defects, like corrosion, will not generate relatively large stresses. However, sharp defects, like cracks, can cause significant stress and under typical pipeline fatigue loads hydrogen can accelerate crack growth. In general, crack and crack like defects are considered to be more critical than corrosion defects when hydrogen is introduced.

Impact of Hydrogen on the Defect Criticality

A clear impact on the acceptable initial crack size was observed especially for axial defects. The critical size of the defects can be back calculated with an assumed design life based on the knowledge of crack growth rate in a specific environment. The effect of hydrogen on the defect criticality is minor under the selected assumptions in the hydrogen/natural gas mixtures with up to 50% hydrogen. A tool was developed to calculate the probability that a pipeline will fail or a defect will lead to a pipeline failure and the failure rate.

Inspection/Monitoring Tools and Inspection Intervals

The current inspection tools were investigated for their abilities to identify the critical defects under hydrogen services. The modified pipeline inspection tools (MFL, TRIAX, and EMAT) can be applied to find critical defects when transporting hydrogen/natural gas. The inspection interval can be determined for different hydrogen concentrations, loads and geometries of pipeline and defects based on the in-line inspection and probability of failure (POF) calculation results. The expected inspection intervals will be shortened for transporting hydrogen/natural gas mixture, especially for higher hydrogen concentrations. Improvement of the in-line inspection tools of their reliability and sensitivity to identify critical cracks will be beneficial to lowering the probability of failure.

Cathodic Protection (CP) Integrity Management

A prototype of an integrated remote monitoring system has been proven feasible for coated pipelines. This system includes data collection system and a modeling tool to provide a real time display of the CP protection levels along the pipeline. The benefit of using this remote monitoring system is to manage the pipeline integrity in the presence of hydrogen with reduced cost.

Repair Methods

Three currently applied repair procedures have been investigated to determine if they can be used for pipeline repair under hydrogen service. The focus was on the pipeline load and the effect of hydrogen on welding activities. Clock Spring, Metallic Sleeve and Weld Deposit can be used to repair the pipelines that co-transport hydrogen and natural gas, but the performance will be slightly reduced in some cases.

Cost of the Integrity Management for Hydrogen Service

The cost of the integrity management is strongly dependent on the individual circumstances including hydrogen concentration, defect distribution, material properties, loads and integrity targets. The potential increase of the total cost will be less than 10% for the inspection and repair costs on corrosion and cracks if: (a) the hydrogen concentration is less than 50% of the natural gas blend, (b) with the maximum operation pressure of 957 psig (66 bars), and (c) the design life of the system is 50 years or less.

Additional Information for Distribution Pipeline Integrity under Hydrogen Services

Major Threats to Distribution Infrastructure

The threats are classified in ASME Standard B31.8S (Managing System Integrity of Gas Pipelines) as:

- 1) Time Dependent Threat
 - External corrosion
 - Internal corrosion
 - Stress corrosion cracking (SCC)
- 2) Stable Threat
 - Manufacturing related (e.g., defective pipe seam or defective pipe)

- Construction related (e.g., defective pipe girth weld, wrinkle bend or buckle, etc.)
- Equipment related (e.g., gasket or O-ring failure, control/relief equipment malfunction, etc.)

3) Time Independent

- Third party/Mechanical damage
- Incorrect operations (incorrect operation procedure)
- Weather related/outside force (cold weather, lightning, heavy rains or floods, earth movements)

The above threats are defined primarily for natural gas transmission system which operate at high pressure and are constructed predominantly with high strength steels which are coated, wrapped or bare. The materials found in distribution pipeline systems are predominantly steel or polyethylene, with some cast iron, wrought iron, other plastics and copper. Some of the threats to transmission pipelines are not applicable to distribution systems. For example, the threat of stress corrosion cracking is not typically a threat to the distribution infrastructure because it is the cracking of a pipeline from the combined influence of tensile stress, a corrosive environment, and a susceptible material. The distribution pipelines do not operate at pressures high enough to produce the stress necessary to create an environment that could include stress corrosion cracking.

With the different materials taken into account, and in view of the incident causes, the nine threats defined for transmission pipelines were expanded to the following fourteen categories of threats for distribution systems which are prioritized in Table 20 [27]. Unlike transmission pipelines, the top two threats to distribution pipelines are the weather-related outside force damage on cast iron and excavation/mechanical damage instead of the time dependent threats from corrosion (external corrosion, internal corrosion or stress corrosion cracking) posed to transmission pipelines. This is because the distribution pipelines are mostly buried in the highly populated area and are frequently subjected to outside force damage.

For the fourteen threats present for natural gas distribution systems, the likelihood of any threat will not be significantly affected by having hydrogen added in the system, but the severity of the hazard may be increased by hydrogen in the case leaking occurs as a result of an incident.

The integrity program may need to be tightened in the future when hydrogen is added to the distribution system. For example, one may need to shorten the inspection intervals to minimize the possibility of pipeline failure, or to implement leak detection or monitoring device for hydrogen. Currently there is no available odorant for hydrogen, and this may require the development of a new odorant. This may lead to a potentially increase of the maintenance cost for the utilities. Since there is no existing integrity program for distribution system (DIMP is just being introduced in the U.S.), the affect on maintenance cost by adding hydrogen cannot be determined.

Summary and GTI's Concluding Remarks on the Integrity under Hydrogen Services

Conclusions in NaturalHy Project on Transmission Pipeline Integrity

The studies on integrity in NaturalHy project is focused on high pressure transportation pipelines. This study concludes that hydrogen can be transported by the existing natural gas pipeline with small adaptations of the current Integrity Management Program. The necessary adaptations depend on the hydrogen concentration and the operating conditions of the individual pipeline. The modifications of current integrity program is considered insignificant if hydrogen in the pipeline is less than 50%, but it requires a detailed investigation for each case and corresponding modification on the upper limitation of hydrogen concentration.

GTI's Comments on Distribution Integrity

The threat of hydrogen addition on distribution integrity has been considered smaller when compared to transmission pipelines. It should be noted that the natural gas distribution systems are very different from transmission pipelines, and it is not possible to simply apply the integrity program for transmission pipeline to distribution systems. One of the important differences of distribution systems from transmission pipelines is the locations, i.e., the distribution pipelines are in populated areas. The level of hydrogen that is acceptable for transmission pipeline may need to be reassessed for distribution systems in terms of the frequency and severity of fire or explosion in the populated area. In addition, the gas leakage in a distribution system is more severe than transmission pipeline, especially in a confined service area. The integrity management for distribution systems under hydrogen services may require the implementation of leak detecting/monitoring devices or sensors. Currently, there is no available odorant for hydrogen, and this becomes an area for further investigation.

It is likely that the maintenance cost for distribution system under hydrogen service will be increased due to the need for increasing inspection frequency and leak detection.

Task 4.6 - End Use-Hydrogen Separation

One of the challenge for using the existing natural gas network to distribute hydrogen is to separate hydrogen from the mixtures at the end use. Currently, pressure swing adsorption (PSA) is the mature technology used in refineries to produce high purity hydrogen. However, this technology requires large scale units which work best with high levels (normally larger than 50%) hydrogen in the mixtures. A smaller scale separation is desired to extract hydrogen from the hydrogen-natural gas mixtures which contains lower levels of hydrogen (mostly likely below 25%) under typical natural gas pipeline conditions. In addition, the purity of the hydrogen extracted from hydrogen-natural gas mixtures has to match the requirements in the specific application.

Hydrogen-selective membranes are commonly seen as the promising technology for the recovery of hydrogen from the feed stream with a low (<30%) hydrogen concentration. The NaturalHy project has focused on developing advanced hydrogen selective membranes for the separation of hydrogen from natural gas/hydrogen mixtures in “Work Package 5 (Task 5.3-5.7)”.

This work was led by *University of Oxford*, and with participation by the *Norwegian University of Science and Technology (NTNU)* and *Compagnie Europeenne des Technologies del'Hydrogene (CETE)*. The objects of this work include:

- Developing membranes to recover hydrogen from hydrogen/natural gas mixtures;
- Investigating the physical properties of the remaining stream and methods to re-establish the gas quality; and
- Performing a cost analysis of the membrane system vs. the commercial PSA systems.

In general, membranes are classified into two major types: dense membranes (e.g., metallic membranes) and microporous membranes (e.g., carbon molecular sieves). Both types of membranes have been investigated in NaturalHy project.

Development of High Selectivity Palladium-Based Membranes

Palladium membranes are the most used technology to recover hydrogen from gas streams with a low hydrogen concentration. In order for these membranes to function efficiently, the entire gas feed stream must be heated to temperatures higher than 350°C. Currently, the commercially available palladium membranes are conventionally “thick” tubular membranes and are very expensive. The object of NaturalHy project is to develop ultra-thin palladium-alloy membranes supported on porous ceramic substrates to achieve coherent, defect-free membranes. One of the processes that can produce a three micrometer thick membrane is electroless plating of palladium onto a porous alumina substrate. The other technology is to deposit thin palladium/silver alloy membranes onto smooth uniform substrates. These membranes operate at 300°C with good hydrogen flux, high recovery and 100% selectivity for hydrogen. The results from this investigation indicate:

- Electroless plating of palladium onto a porous alumina substrate can produce the membranes that meet or exceed 2010 US DOE targets for membrane hydrogen flux at 400°C.
- Depositing thin palladium alloyed with silver and copper is not successful because the manufacturing defects in the ceramic support give rise to pin-hole leaks and mechanical problems.
- Magnetron vacuum sputtering is a potential alternative technique, but the challenge is to use perfectly smooth surfaces such as silicon wafers and polymers as the forming surface and then remove of the deposited membrane.

Development of Carbon-Based Membranes

Though palladium membranes are promising for recovery of hydrogen from feed streams with a low (<30%) hydrogen, these membranes have to be heated to temperatures higher than 350°C in order to

function efficiently. This temperature requirement increases the cost and energy input. Carbon-based membranes are able to separate hydrogen at lower or ambient temperature, however the efficiency with respect to flux and selectivity vary depending on temperature and pressure.

Two types of new carbon-based membrane materials suitable for the recovery of hydrogen from hydrogen/natural gas mixtures have been investigated in this project.

Carbon Molecular Sieves (CMS)

Carbon molecular sieves are formed by carbonization (pyrolysis) of a polymeric precursor at temperatures between 400 and 800°C. This is usually performed under vacuum or an inert gas such as nitrogen using cellulose derived from plentiful wood pulp which is cheap and abundant.

Periodical regeneration of carbon membranes can recover hydrogen permeation properties and is beneficial to improve long-term performance of the membranes. A regeneration technique that can be applied on-stream while the membrane is in operation has been developed.

The results from this investigation indicate that the CMS sieves can effectively recover hydrogen from the pipeline networks that transport hydrogen/natural gas blends. It provides a greater permeability and better selectivity (up to 98%) than conventional polymer membranes and operates at temperatures between 30°C and 90°C. Further development is ongoing to develop larger scale membrane modules and perform lifetime testing.

A Mixed Matrix (MM) Material

The development of the MM-membrane did not provide successful results and the development of this membrane was terminated in this project.

Development of Hybrid Membrane Separation System

It is most likely that the beneficial characteristics from metallic and carbon based membranes can be combined by producing a hybrid membranes to provide an increase in efficiency and flexibility together with lower cost. A carbon based membrane can be used as at the first stage to achieve higher hydrogen content (up to 98%) at almost room temperature and then followed by a palladium membrane for final purification of hydrogen. A hybrid separation system is proposed for further development, see Figure 11.

Summary on Hydrogen Separation Technologies

Electroless plating of palladium and carbon molecular sieves are the two technologies that can be further developed for hydrogen separation from hydrogen/natural gas blends transported by a natural gas pipeline network. A Palladium membrane can provide high purity hydrogen, but is expensive and has to operate at 300°C. A CMS membrane is low cost and can operate at temperature between 30°C and 90°C, but the maximum hydrogen content obtained using a CMS membrane is 98%.

The most promising technique in the future would be a hybrid separation system. This could be constructed by combining palladium and CMS membrane technology. The cost analysis performed in this study indicates that the hybrid system including ancillaries is potentially cheaper than separation by PSA. Small scale PSA systems are under development, but it is problematic for PSA to separate hydrogen from streams with hydrogen content less than 40%, an additional PSA or a CMS membrane can be used in the first stage to concentrate the hydrogen level in the feed.

The analysis performed in this study also shows that the downstream gas quality will not be adversely affected since the Wobbe index and heating value will not be outside the statutory requirements.

Task 4.7 – Impacts (Environmental and Macroeconomic Benefits)

The impact from adding hydrogen into natural gas systems was assessed in “NaturalHy Project Work Package 1”. The review of this study by GTI is included in Task 4.1, and below is a summary of the major impacts on environmental and macroeconomic benefits from adding hydrogen in natural gas:

- 1) Significant reduction of greenhouse gas emissions if hydrogen is produced from biomass, wind power, and nuclear power.
- 2) Some advantage on greenhouse gas emissions with hydrogen production from fossil fuels with CCS, but no benefits for decreasing primary energy demand or energy resource depletion.
- 3) Potential benefits of selective extraction of hydrogen (this depend on the performance of the separation technology and the subsequent use of the hydrogen and the residual gas).
- 4) Potential benefits on improving air quality by reducing sulfur dioxide, oxides of nitrogen and particulate emissions if hydrogen is used in transportation and displaces conventional diesel fuel.
- 5) Potential benefit on “greening” natural gas if the hydrogen/natural gas mixture is used directly in existing appliances for heat production and electricity generation.

Conclusions

GTI reviewed the studies performed by the *NaturalHy* Project on using natural gas network for hydrogen services. The scope of this review covers the seven aspects that have been investigated in *NaturalHy* including “Life Cycle Assessment”, “Safety”, “Leakage Assessment”, “Durability”, “Integrity”, “End Use” and “Environmental and Macroeconomic Impacts”. In addition to the reports and publications from the *NaturalHy* Project, GTI included the report published by the Greenhouse Gas R&D Programme sponsored by International Energy Agency (IEA) and other related publications in this review to develop a comprehensive understanding of the major benefits and limitation of using the existing natural gas network for transporting hydrogen.

The aim of this review was to provide a scientific basis and engineering assessment of the potential impact from hydrogen on the US natural gas distribution infrastructure when hydrogen is blended into the natural gas network. The conclusions of this review not only include the summary of the findings and conclusions from the research investigations, but also include GTI’s comments made for US distribution system by integrating the research findings with the particular conditions for the distribution infrastructure. The main conclusions of the seven tasks are summarized below:

1) Task 4.1 Life Cycle Assessment

The life cycle assessment in the *NaturalHy* project supports the beneficial effects on the environment by adding hydrogen to natural gas, which include the reduction of greenhouse emission and improving the air quality. However, there is not enough information in this study to support that there is a benefit from the standpoint of economy and employment. No concluding remarks were made in this aspect.

2) Task 4.2 Safety

The research findings indicate that the probability of ignition and the severity of explosion of pipeline systems are increased by adding hydrogen. The risk increased by blending hydrogen into natural gas pipeline systems is related to the hydrogen levels in the gas mixtures, and the increase is slight for hydrogen addition up to 20%.

GTI performed a quantitative risk assessment on US natural gas distribution systems for carrying hydrogen containing natural gas. Compared to the current situation with natural gas, the risks in natural gas distribution systems are increased by adding hydrogen into the system. The assessment results indicate that the risks in distribution mains and service lines are different, especially at higher levels of hydrogen in the system.

If less than 20% hydrogen is introduced into distribution system, the overall risk is not significant for both distribution mains and service lines, but the service lines are more impacted than mains because they are mostly in confined spaces.

If the hydrogen level in natural gas increases beyond 20%, the overall risk in service lines can significantly increase and the potential hazards can become severe, while the overall risk in distribution mains still can be moderate at up to 50% hydrogen.

For hydrogen level above 50% in natural gas, the risks in both distribution mains and service lines significantly increase compared to the situation with natural gas, and the overall risk in distribution system becomes severe.

3) Task 4.3 Leakage

Hydrogen is more mobile than methane in many polymer materials including the plastic pipes and elastomeric seals used in natural gas distribution system. The permeation coefficient of hydrogen is higher through most of the elastomeric sealing materials vs. plastic pipe materials. But the plastic

pipes have much larger surface area compared to the seals. Therefore, the leaks through pipe walls accounts for the major gas loss in the systems.

A calculation based on the literature data for the permeation coefficient of hydrogen and methane in the polyethylene indicates that the majority of the gas loss is from the pipes (pipe wall) in distribution mains which operate at 60 psig (4.1 bar) or higher. The gas loss from the total of 414,830 miles of polyethylene pipes with the sizes less than 2" in the entire distribution mains is about 40 million cubic feet per year if 20% hydrogen is added into natural gas pipeline system. Though this amount of gas loss is almost double the total gas loss when the systems deliver only natural gas, it is still considered insignificant from the economic point of view. Furthermore, this calculation may over estimate the gas loss because the permeation coefficient in the literature is considered larger than the experimental measurements using pipe test under actual operating pressures, especially at lower pressure. Further investigation may be necessary for accurately quantifying the gas loss.

The amount of gas loss from service lines is negligible from the economy point of view, but the gas loss into a confined space may increase hydrogen concentration to levels that may become a threat from the safety standpoint. In addition, the gas leak from the elastomeric seals at the joints in service lines may increase the risk in confined spaces.

Further investigation on the pipe and seal materials can provide a basis to accurately estimate the gas leakage through pipes and seals in order to determine if the leakage in a confined space, over time, will present a safety risk and if it is required to implement a leak detection/monitoring device.

4) Task 4.4 Durability

The metallic pipes in US distribution systems are primarily made of low strength steel, typically API 5L A, B, X42 and X46 in distribution mains. They are not the type of steels that are susceptible to hydrogen induced brittle cracking. In addition, at the stress level generated in natural gas distribution system, hydrogen induced failures are not major integrity concerns for the steel pipes in distribution system.

For the other metallic pipes including ductile iron, cast and wrought iron, and copper pipes, there is no concern of hydrogen damage under general operating conditions in natural gas distribution systems.

There is no major concern on the hydrogen aging effect on PE or PVC pipe materials. Most of the elastomeric materials used in distribution system are also compatible with hydrogen.

The deviation of a gas meter with hydrogen/methane mixtures varies with the manufacture's detail of the meter design. Nonetheless, the deviation is acceptable based on the requirement for recalibration (<4%) when they are measuring a gas mixture containing less than 50% hydrogen. The meters may not need to be tuned under the potential hydrogen levels (<50%) in natural gas pipeline that are transporting hydrogen/natural gas blends.

One of the remaining gaps needs to be addressed for the durability issues is the potential contaminants in hydrogen gas that may be introduced into the network.

5) Task 4.5 Integrity

In the NaturalHy Project and some other research programs, the focus on the integrity issues has been on the transmission pipelines because of the concerns of high operating pressures (up to 2000 psig (138 bar)) and the pipeline steels that are subject to hydrogen induced cracking. It is concluded in the NaturalHy Project that hydrogen can be transported by the existing natural gas pipeline with small adaptations of the current Integrity Management Program. The necessary adaptations depend on the hydrogen concentration and the operating conditions of the individual pipeline. The necessary modifications are not significant with up to 50% hydrogen addition, but a detailed investigation for

every case is mandatory and the upper limitation on hydrogen concentration may be reduced.

It should be noted that the natural gas distribution systems are very different from transmission pipelines, and it is not possible to simply apply the integrity program for transmission pipelines to distribution systems. One of the important differences of distribution systems from transmission pipeline is the locations of these systems. The level of hydrogen that is acceptable for transmission pipeline may need to be reassessed for distribution systems in terms of the frequency and severity of fire or explosion in a highly populated area.

In addition, the hazards arising from gas leakage in a distribution system may be more severe than in transmission pipelines, especially in a confined service area. The integrity management for distribution systems under hydrogen services may require the implementation of leak detecting or a monitoring device or sensor. Currently, there is no available odorant for hydrogen, and this becomes an area for further investigation.

It is likely that the maintenance cost for distribution systems under hydrogen service will be increased due to the need for increasing inspection frequency and implementing leak detection.

6) Task 4.6 End Use Hydrogen Separation

Electroless plating of palladium membranes and carbon molecular sieves are the two technologies that can be further developed for hydrogen separation from hydrogen/natural gas blends transported by a natural gas pipeline. Palladium membranes can provide high purity hydrogen, but they are expensive and have to operate at 300°C. CMS membranes are low cost and can operate at temperature between 30°C and 90°C, but the maximum hydrogen concentration obtained using CMS membranes is 98%.

The most promising technique is to making a hybrid separation system by combining palladium and CMS membranes. The cost analysis performed in this study indicates that the hybrid system, including ancillaries, is potentially cheaper than separation by PSA.

Small scale PSA systems are also under developments that include an additional PSA or a CMS membrane in the first stage to concentrate the hydrogen level in the feed.

Downstream gas quality will not be adversely affected since the Wobbe index and heating value will not be outside the statutory requirements.

7) Task 4.7 Environmental Impact

Adding hydrogen in natural gas can significantly reduce greenhouse gas emissions if hydrogen is produced from biomass, wind power and or nuclear power. There are also some advantages related to greenhouse gas emissions with hydrogen production from fossil fuels with CCS, but hydrogen from this source has no benefits for decreasing primary energy demand or energy resource depletion.

Adding hydrogen in natural gas also has the potential benefits of improving air quality by reducing sulfur dioxide, oxides of nitrogen and particulate emissions if hydrogen is used in transportation and displaces conventional diesel fuels. It could also green natural gas if the hydrogen/natural gas mixture is used directly in existing appliances for heat production and electricity generation.

END OF REPORT

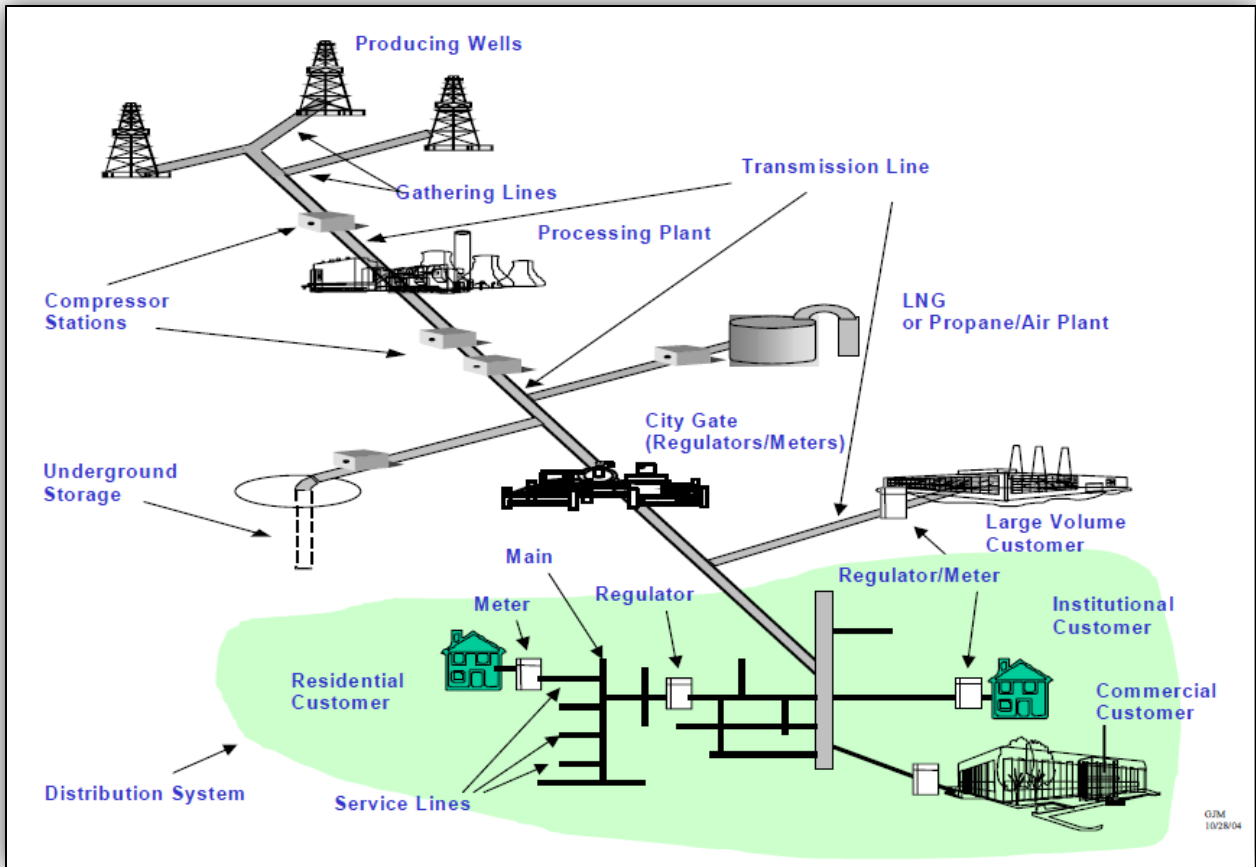

Figure 1. Schematic of the Natural Gas Delivery Pipeline Infrastructure*

Note:

*: Figure from AGF report “Safety Performance and Integrity of the Natural Gas Distribution Infrastructure” [27].

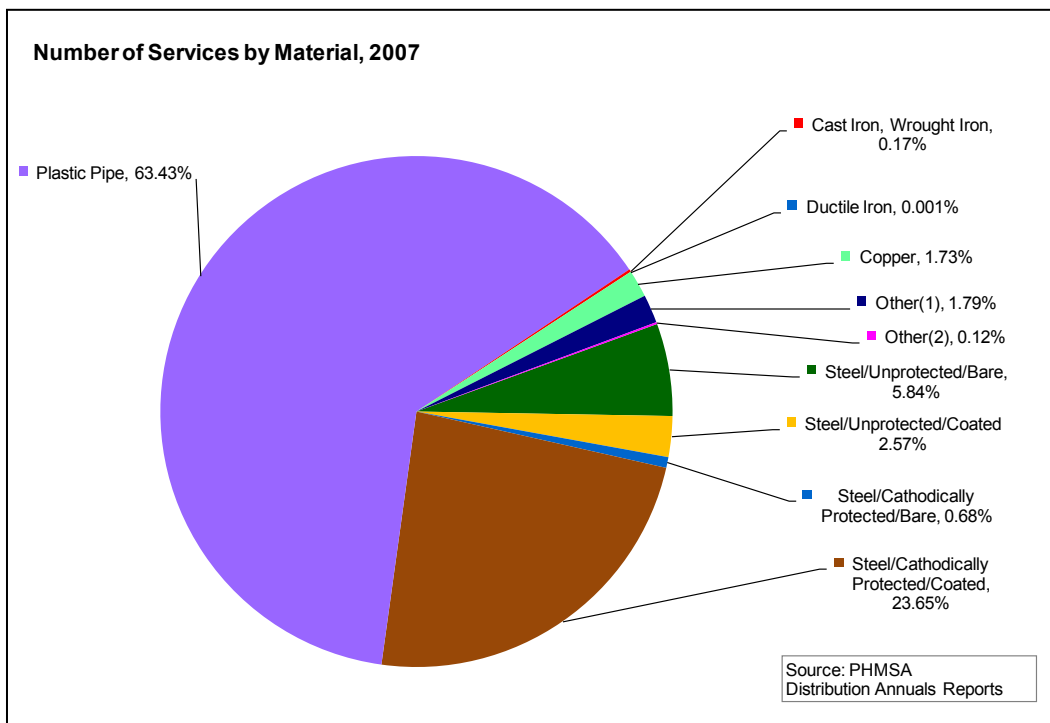
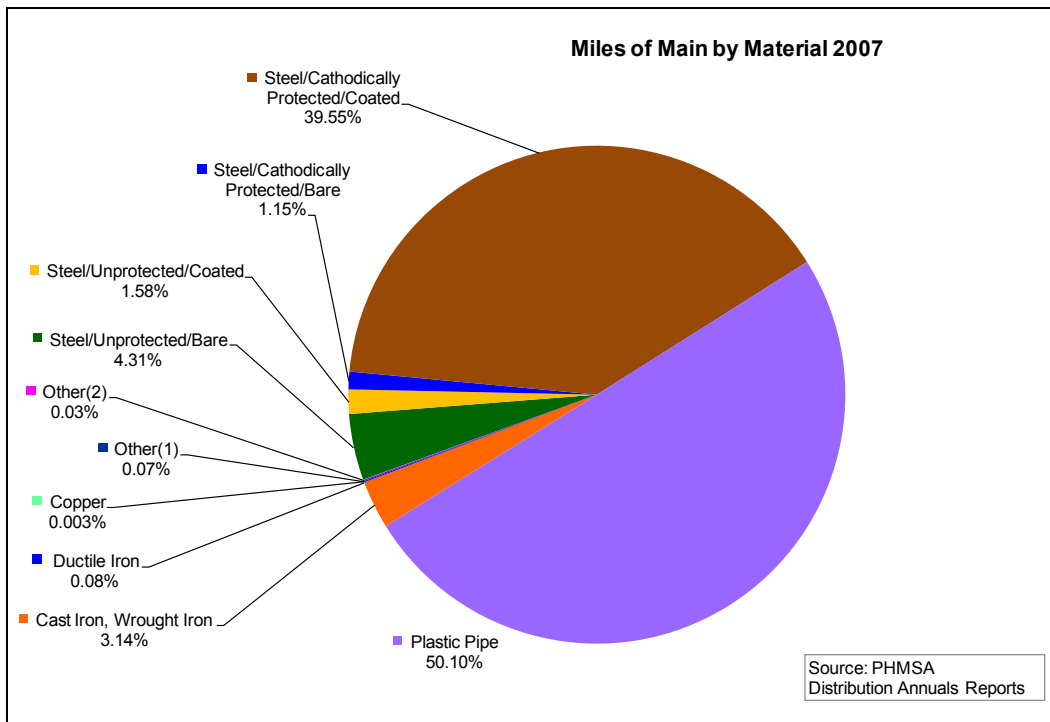

Figure 2. Piping Materials of Mains and Service Lines in Distribution Systems*

Note:

*: Original data from DOT 2007 Annual Report [25]

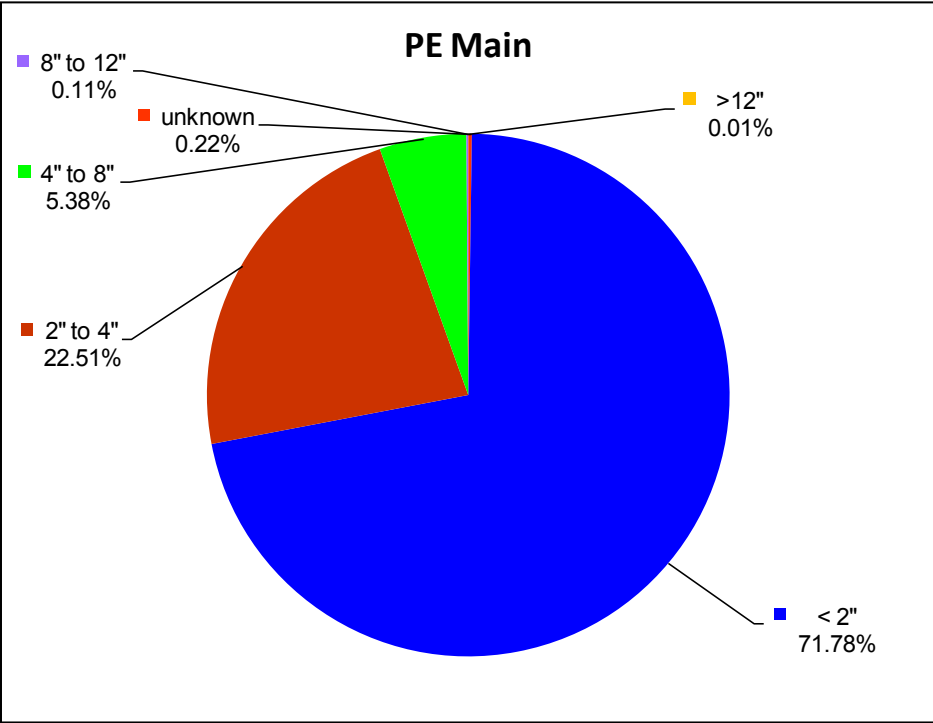
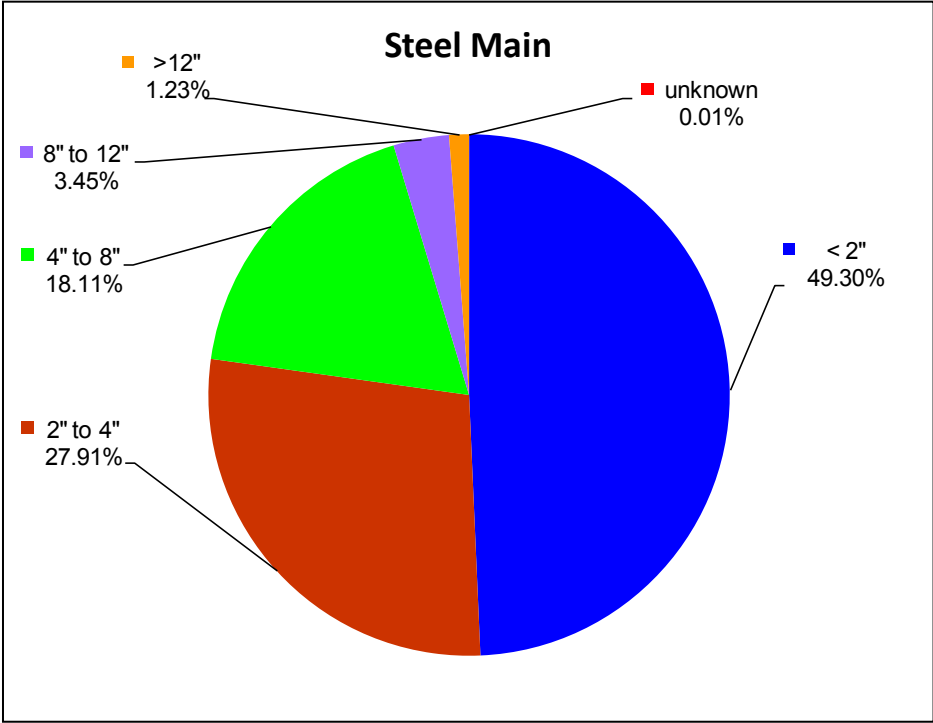

Figure 3. The Distribution of Pipe Size of Steel and PE Pipes in Distribution Mains*

Note:

*: Original data from DOT 2007 Annual Report [25]

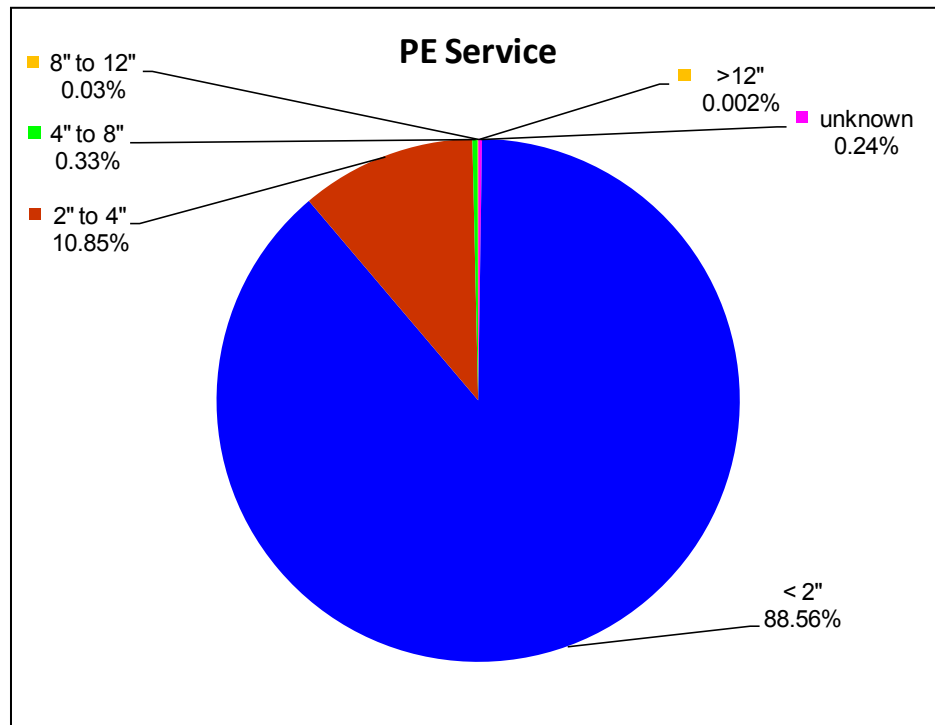
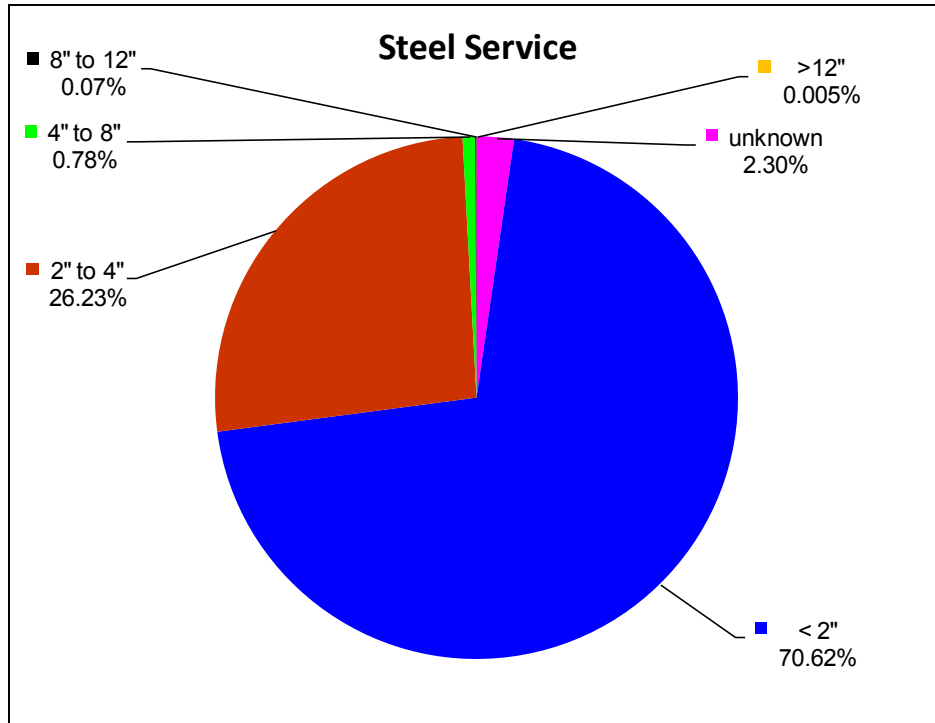

Figure 4. The Distribution of Pipe Size of Steel and PE Pipes in Service Lines*

Note:

*: Original data from DOT 2007 Annual Report [25]

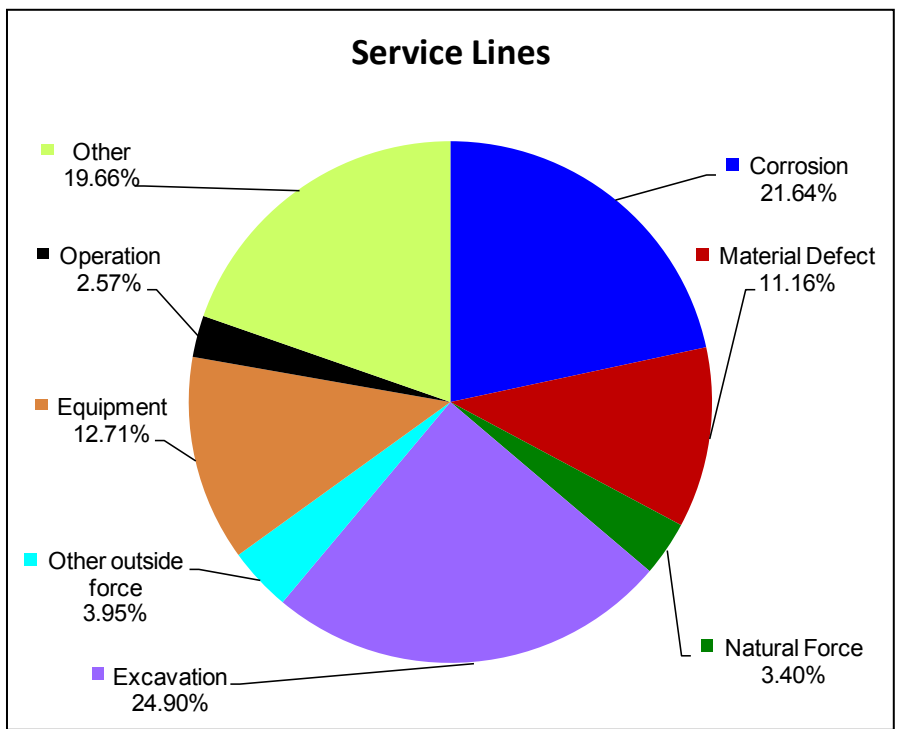
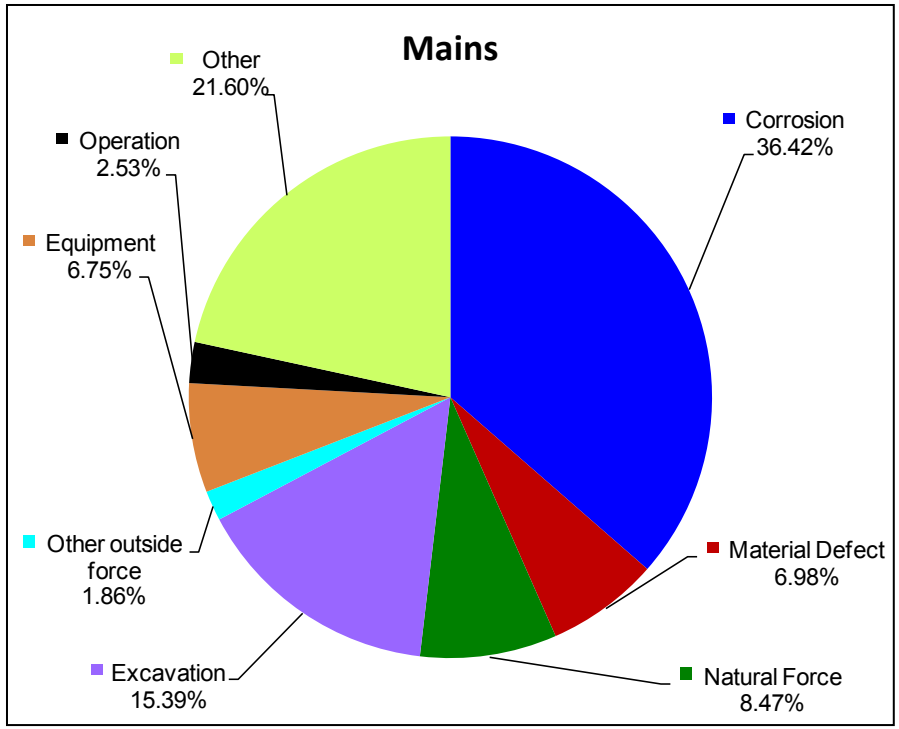

Figure 5. Statistical Data for Leak Incidents in Distribution Mains and Service Lines*

Note:

*: Original data from DOT 2007 Annual Report [25]

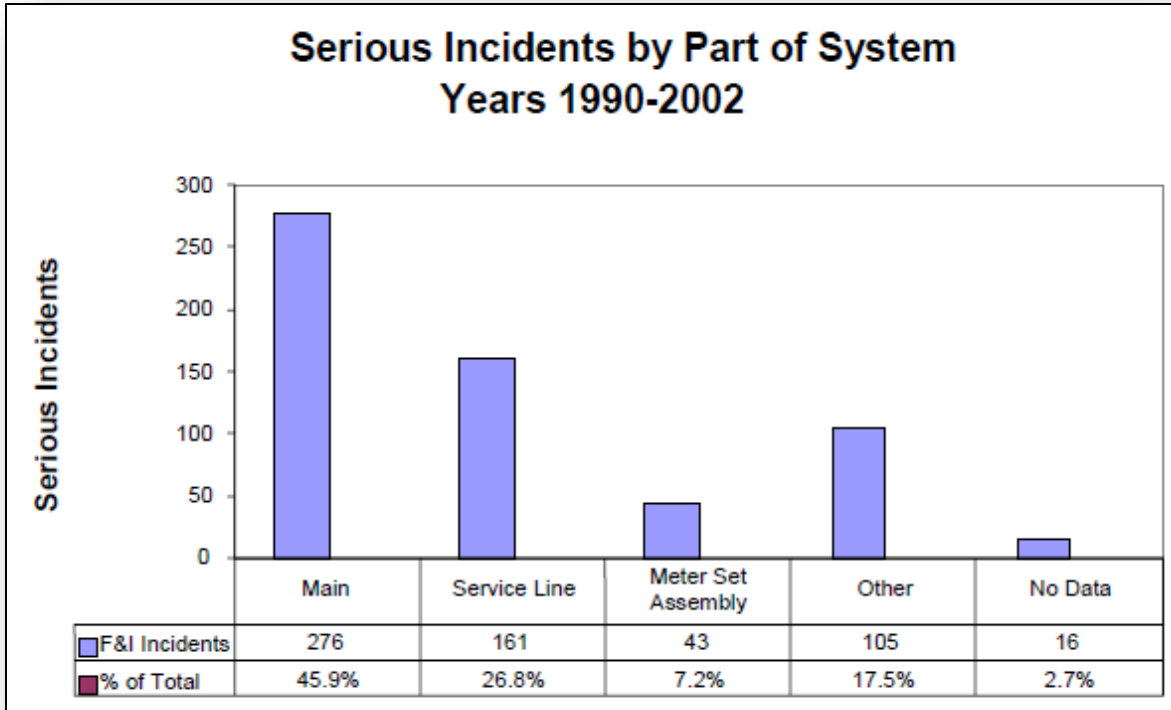

Figure 6. Incidents by Part of the Distribution System*

Note:

*: Plot from AGF report “Safety Performance and Integrity of the Natural Gas Distribution Infrastructure” [27].

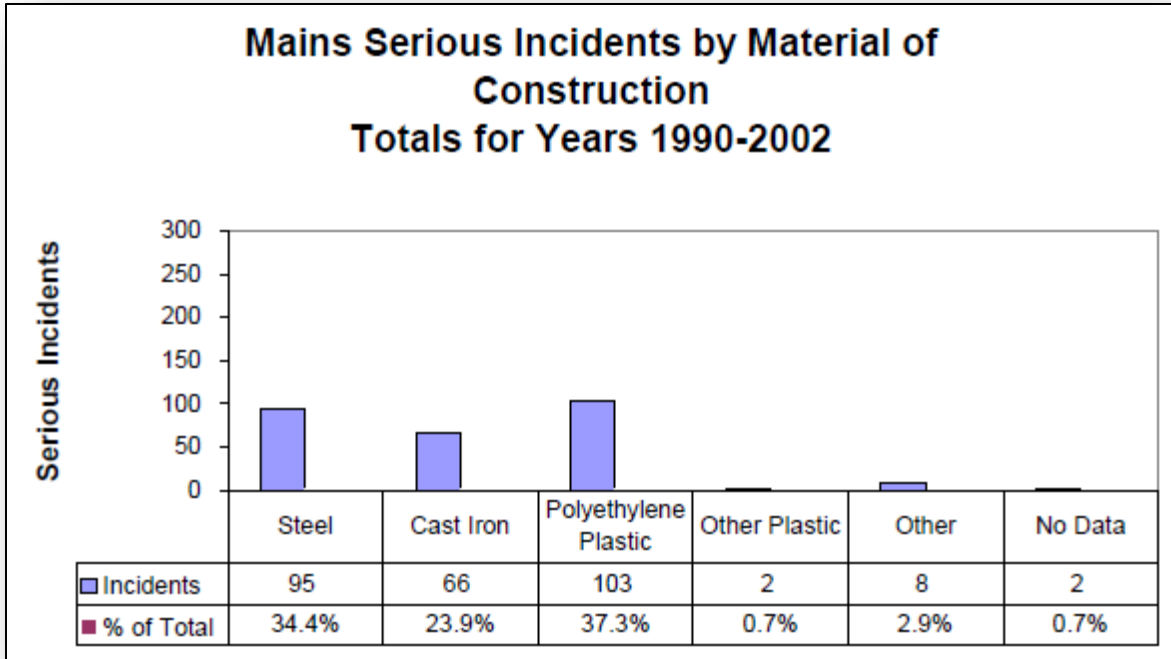

Figure 7. Serious Incidents by Construction Materials of Mains*

Note:

*: Plot from AGF report “Safety Performance and Integrity of the Natural Gas Distribution Infrastructure” [27].

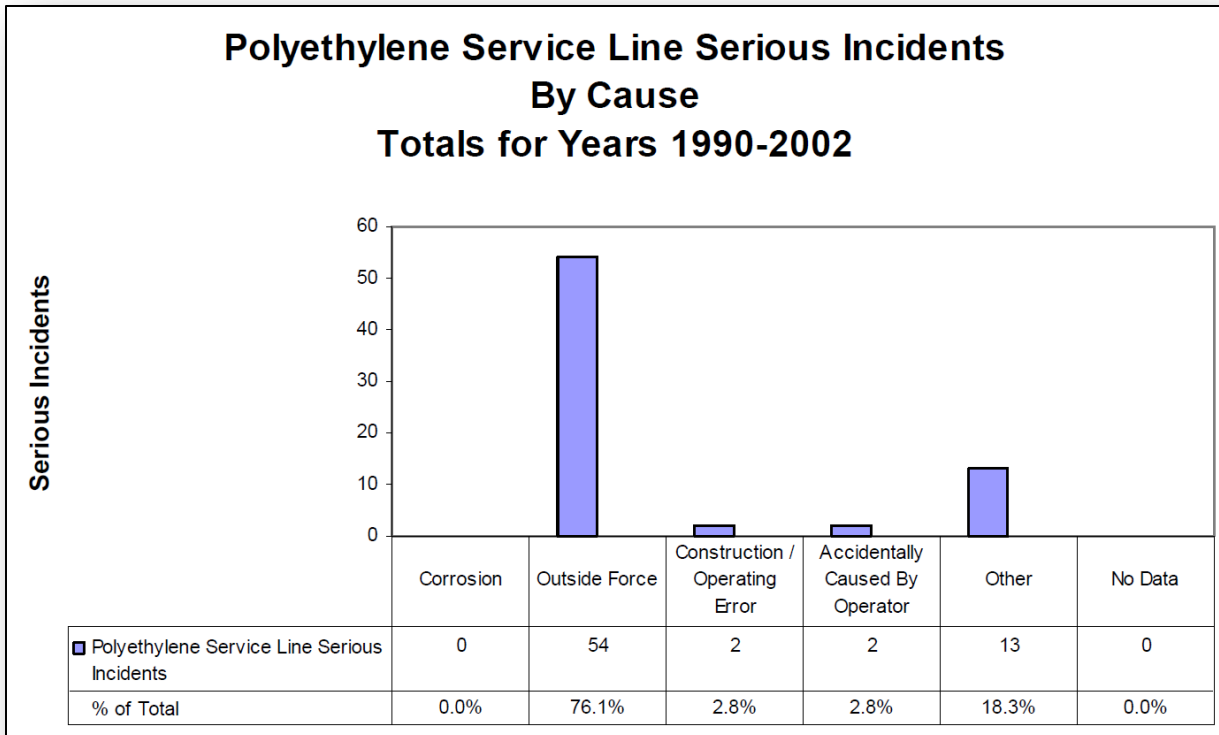
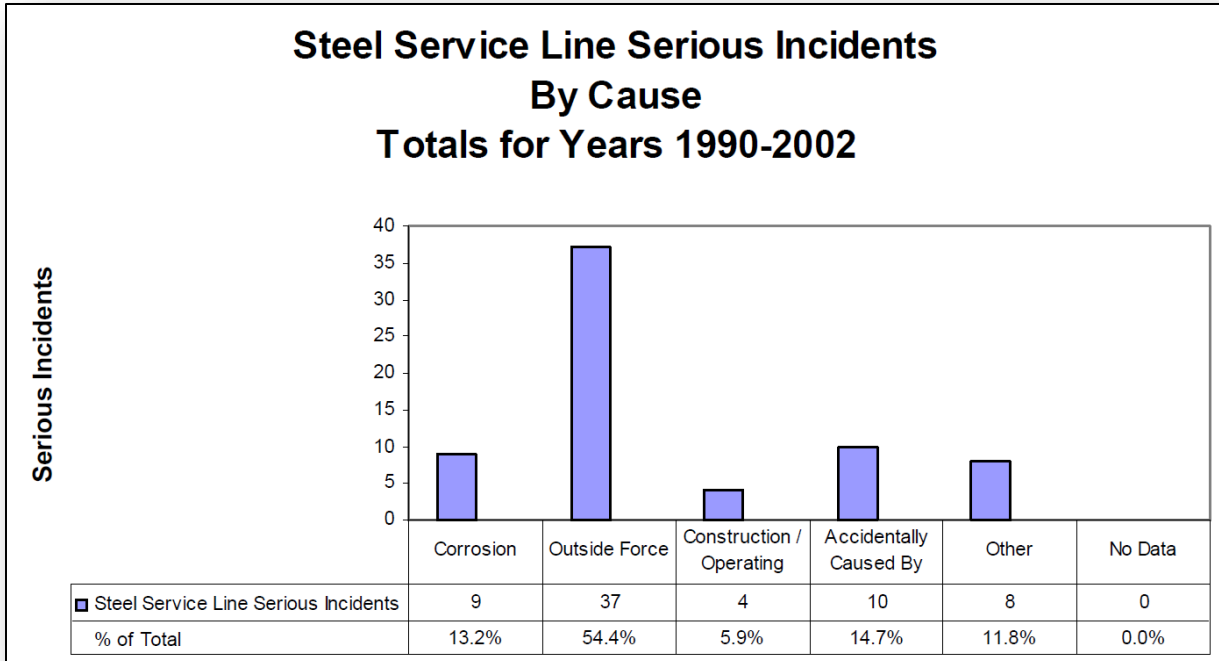

Figure 8. Serious Incidents in Steel and Polyethylene Service Lines by Cause*

Note:

*: Plot from AGF report “Safety Performance and Integrity of the Natural Gas Distribution Infrastructure” [27].

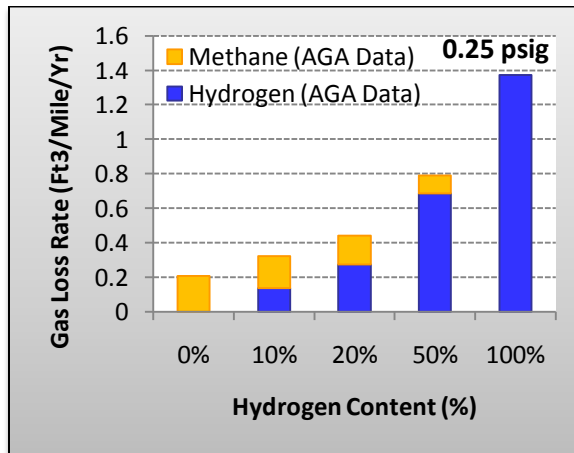
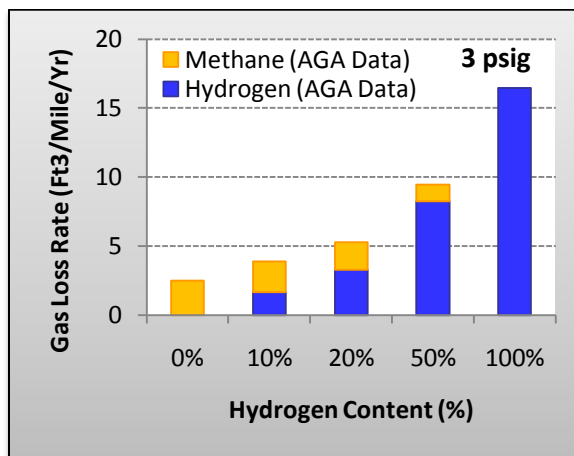
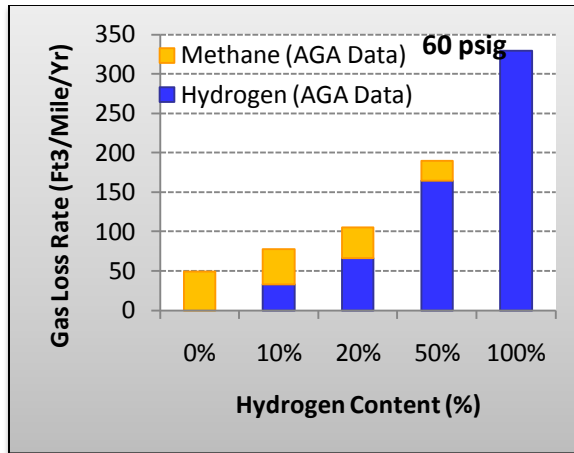

Figure 9. The Calculated Gas Loss Rate vs. Hydrogen Concentration in Hydrogen/Methane Mixtures at the Typical Distribution Operating Pressures (60 psig (4.1 bar), 3 psig (210 mbar) and 0.25 psig (17.2 mbar))*

Note:

*: The data are calculated by Equation (2) using the permeation coefficient data in Table 16 from AGA Handbook “Plastic Pipe Manual for Gas Service” [29].

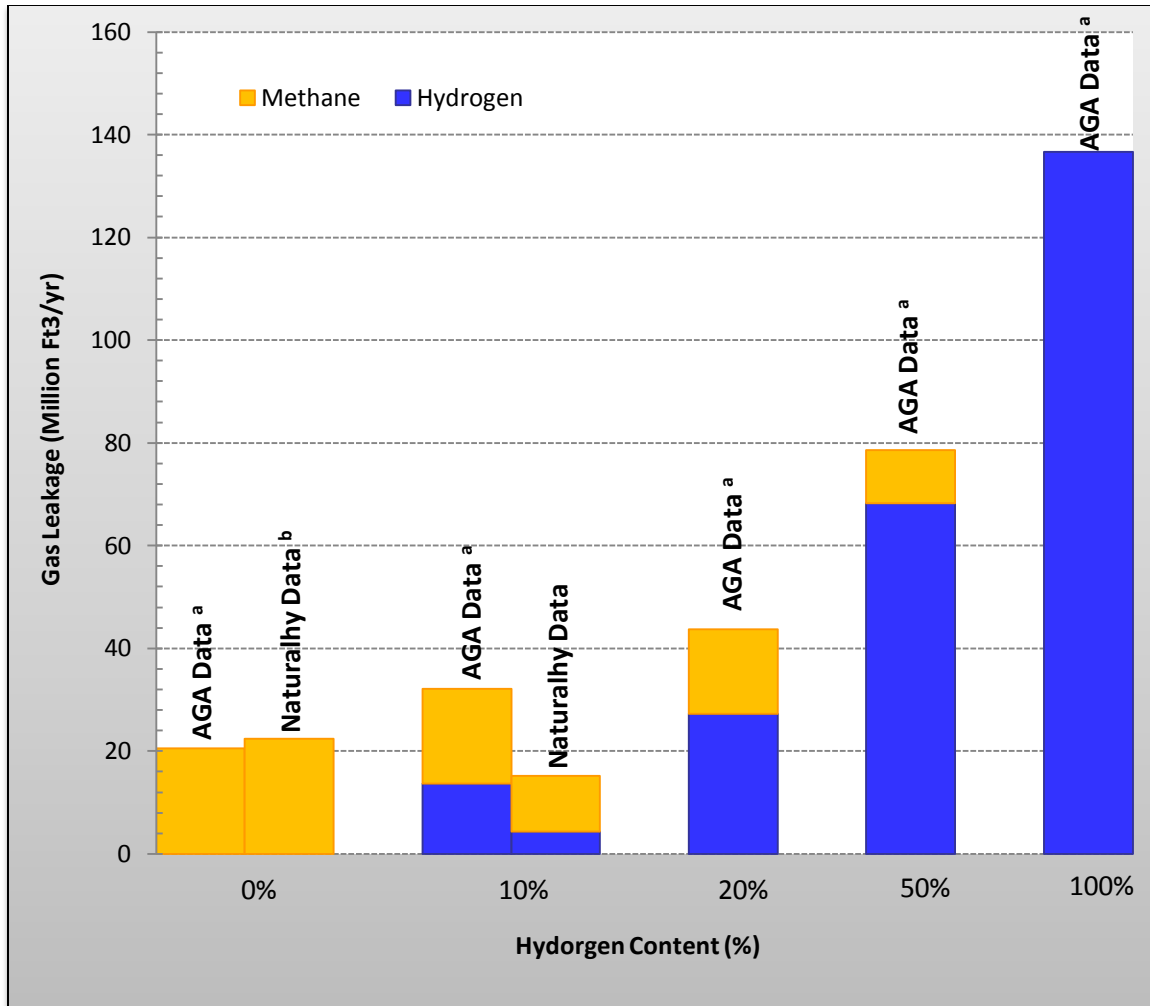

Figure 10. The Calculated Gas Loss from the Gas Mixtures Containing Different Levels of Hydrogen in Distribution System at 60 psig (4.1 bar) Operating Pressure

Note:

a: AGA Data: The data are calculated by Equation (2) using the permeation coefficient data in Table 16 from AGA Handbook “Plastic Pipe Manual for Gas Service” [29].

b: The original data are from the experimental test results in the paper of “Evaluation of the Permeability to CH₄ and H₂ of PE Currently Used in Gas Distribution Networks” [18], and are converted to the English unit.

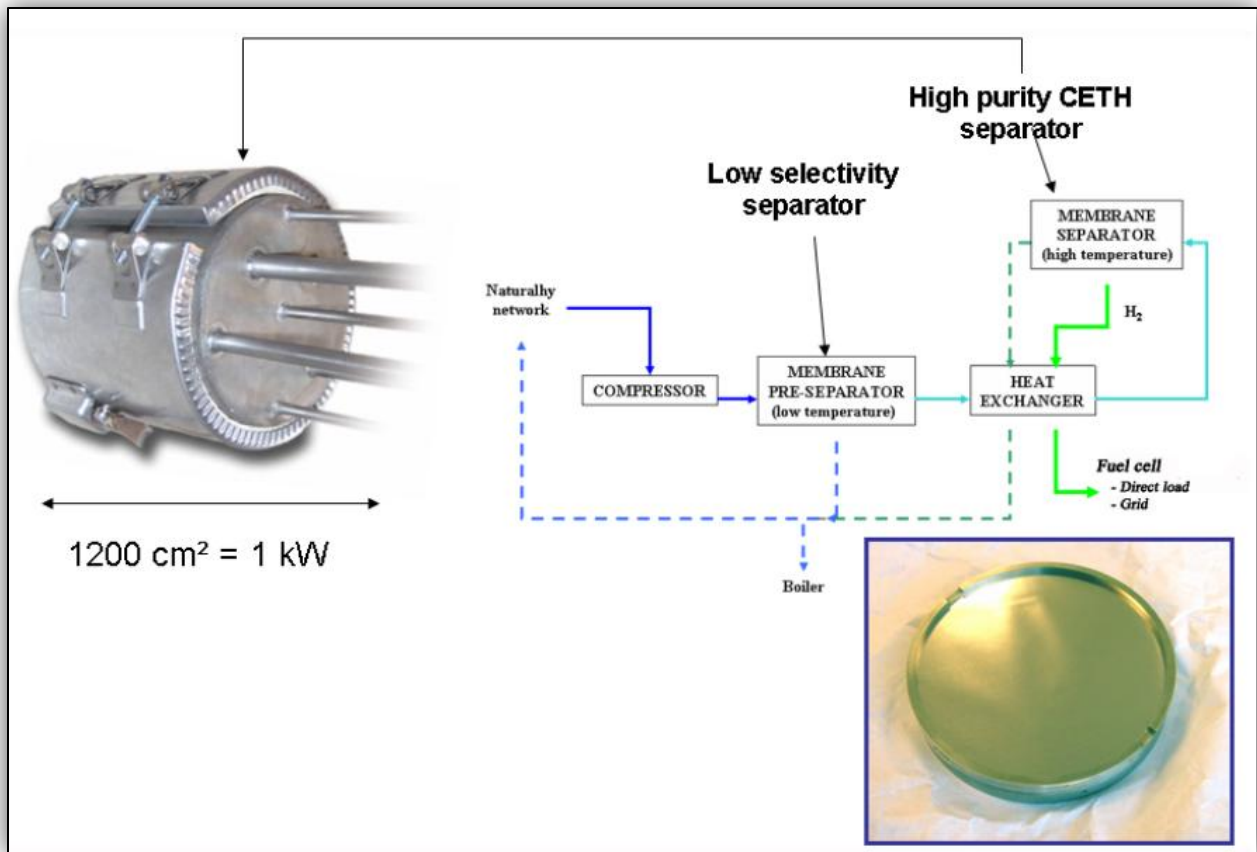

Figure 11. A Hybrid Separation Membrane System for Hydrogen Recovery*

Note:

*: Plot from NaturalHy “Interim Report on Membrane Development for Hydrogen Separation” [7].

Table 1. Regulation Mandated Inspection of Gas Pipeline Facilities*

Distribution	Transmission
Buried pipeline corrosion protection electrical current readings at test stations spaced along the pipeline must be checked at least once a year	Buried pipeline corrosion protection electrical current readings at test stations spaced along the pipeline must be checked at least once a year
Buried pipeline external corrosion control systems must be checked at least 6 times a year	Buried pipeline external corrosion control systems must be checked at least 6 times a year
Equipment monitoring for internal corrosion at points where the risk of such exists must be checked at least once in 6 months	Equipment monitoring for internal corrosion at points where the risk of such exists must be checked at least once in 6 months
Distribution pipelines exposed to the atmosphere must be checked for external corrosion at least once in every 3 years.	Onshore pipelines exposed to the atmosphere must be checked for external corrosion at least once in every 3 years; offshore pipes exposed to the atmosphere must be checked at least once a year.
Whenever the operator has knowledge that any portion of its buried ferrous distribution pipeline is exposed, the exposed portion must be examined for evidence of external corrosion or if the coating is deteriorated.	Whenever the operator has knowledge that any portion of its buried transmission pipeline is exposed, the exposed portion must be examined for evidence of external corrosion or if the coating is deteriorated.
Operator carries out continuing surveillance of its facilities to determine and take appropriate action concerning changes in population density near the pipeline, failures, leakage history, corrosion and other unusual operating and maintenance conditions.	Operator carries out continuing surveillance of its facilities to determine and take appropriate action concerning changes in population density near the pipeline, failures, leakage history, corrosion and other unusual operating and maintenance conditions.
If a segment of pipe is determined to be in unsatisfactory condition, but no immediate hazard exists, the operator must initiate a program to recondition that segment or phase it out. If this is not possible, the operator must reduce the operating pressure of the pipeline, in accordance with prescribed guidelines. If an immediate hazard exists, the operator must take prompt action to repair the segment.	If a segment of pipe is determined to be in unsatisfactory condition, but no immediate hazard exists, the operator must initiate a program to recondition that segment or phase it out. If this is not possible, the operator must reduce the operating pressure of the pipeline, in accordance with prescribed guidelines. If an immediate hazard exists, the operator must take prompt action to repair the segment.
Distribution pipelines in places or structures where anticipate physical movement or external loading could take place must be patrolled at least 4 times a year in business districts and twice a year outside business districts.	Each operator must patrol its transmission pipeline right-of-way at intervals between 4 times and once a year, depending on certain risk factors.

Note:

*: Table from AGF report “Safety Performance and Integrity of the Natural Gas Distribution Infrastructure” [27].

Table 1. Regulation Mandated Inspection of Gas Pipeline Facilities [27] (Continued)

Distribution pipelines in business districts must be checked for leaks at least once a year including tests for gas presence in subterranean facilities and other areas near a leak.	Transmission pipelines carrying odorized gas must be checked for leaks at least once a year.
Distribution pipelines outside business districts must be checked for leaks at least once every 5 years. Where electrical readings for corrosion protection are impractical, the leak checks must be at least once every 3 years.	Emergency shutdown devices at gas compressor stations must be tested at least once a year.
Disconnected gas service lines must be re-tested before being reconnected.	
Each distribution line valve that may be necessary for the safe operation of the system must be inspected at intervals not exceeding one year.	Each transmission line valve must be inspected and partially operated at least once a year.
Each pressure limiting and pressure regulating station must be inspected and tested at least once a year. This includes inspection of the gas pressure history recorded at these stations.	Each pressure limiting and pressure regulating station on the transmission pipeline must be inspected and tested at least once a year. This includes inspecting the gas pressure history recorded at these stations.
Pressure relief devices must be tested at least once a year for the ability to protect the pipeline from over pressure	Pressure relief devices on the pipeline or at compressor stations to must be tested at least once a year for the ability to protect the pipeline from overpressure.
If larger than 200 cubic feet in size, each underground vault housing pressure regulating or pressure limiting equipment must be tested for gas leaks at least once a year.	If larger than 200 cubic feet in size, each underground vault housing pressure regulating or pressure limiting equipment must be tested for gas leaks at least once a year.
(a) A combustible gas in a distribution line must contain a natural odorant or be odorized so that at a concentration in air of one-fifth of the lower explosive limit, the gas is readily detectable by a person with a normal sense of smell.	After December 31, 1976, a combustible gas in a transmission line in a Class 3 or Class 4 location must contain a natural odorant or be odorized so that a concentration in air of one-fifth of the lower explosive limit, the gas is readily detectable by a person with a normal sense of smell unless: <ul style="list-style-type: none"> (1) At least 50% of the length of the line downstream from that location is in a Class 1 or Class 2 location; (2) The line transports gas to certain facilities; (3) In the case of a lateral line which transports gas to a distribution center, at least 50% of the length of that line is in a Class 1 or Class 2 location; or (4) The combustible gas is hydrogen intended for use as a feedstock in a manufacturing process.
Odorant concentrations must be periodically monitored using test instruments.	Odorant concentrations must be periodically monitored using test instruments.

Note:

*: Table from AGF report “Safety Performance and Integrity of the Natural Gas Distribution Infrastructure” [27].

Table 2. Pipe Sizes and Materials in Distribution Systems*

Type	Size	Quantity	Steel	Ductile Iron	Copper	Wrought/ Cast Iron	PVC	PE	ABS	Other	Total by Size
Mains	Unknown	Miles	44	0	0	3	88	1290	234	9	1667
		%	0.00	0.00	0.00	0.00	0.01	0.11	0.02	0.00	0.14
	< 2"	Miles	275599	0	33	1199	18061	414831	2268	530	712520
		%	22.95	0.00	0.00	0.10	1.50	34.54	0.19	0.04	59.33
	2" to 4"	Miles	156023	214	3	15424	3444	130091	251	157	305609
		%	12.99	0.02	0.00	1.28	0.29	10.83	0.02	0.01	25.45
	4" to 8"	Miles	101239	470	1	15913	366	31077	4	29	149099
		%	8.43	0.04	0.00	1.32	0.03	2.59	0.00	0.00	12.41
	8" to 12"	Miles	19273	70	0	3146	0	625	0	5	23119
		%	1.60	0.01	0.00	0.26	0.00	0.05	0.00	0.00	1.93
	>12"	Miles	6875	73	0	1985	0	37	0	2	8973
		%	0.57	0.01	0.00	0.17	0.00	0.00	0.00	0.00	0.75
	Total by Materials	Miles	559053	828	36	37670	21959	577950	2757	732	1200987
		%	46.55	0.07	0.00	3.14	1.83	48.12	0.23	0.06	100.00
Services	Unknown	Numbers	486667	0	70	52	918	97283	453	487767	1073210
		%	0.75	0.00	0.00	0.00	0.00	0.15	0.00	0.75	1.66
	< 1"	Numbers	14953056	0	703688	96381	224150	36183571	9870	723781	52894497
		%	23.07	0.00	1.09	0.15	0.35	55.84	0.02	1.12	81.62
	1" to 2"	Numbers	5554217	0	416609	10881	32866	4431757	642	60707	10507679
		%	8.57	0.00	0.64	0.02	0.05	6.84	0.00	0.09	16.21
	2" to 4"	Numbers	164653	0	582	621	244	132842	130	525	299597
		%	0.25	0.00	0.00	0.00	0.00	0.20	0.00	0.00	0.46
	4" to 8"	Numbers	15260	332	15	236	7	11066	0	80	26996
		%	0.02	0.00	0.00	0.00	0.00	0.02	0.00	0.00	0.04
	>8"	Numbers	1050	46	0	12	0	839	0	1	1948
		%	0.00	0.00	0.00	0.00	0.00	0.00	0.00	0.00	0.00
	Total by Materials	Numbers	21174903	378	1120964	108183	258185	40857358	11095	1272861	64803927
		%	32.68	0.00	1.73	0.17	0.40	63.05	0.02	1.96	100.00

Note:

*: Original data from DOT 2007 Annual Report [25]

Table 3. Steel Grades for Distribution Pipelines and Their Material Properties*

API 5L	Min Yield Strength		Min Ultimate Tensile Strength		Min Elongation
	ksi	MPa	ksi	MPa	%
Grade					
A	30	207	48	331	-
B	35	241	60	413	22.5
X42	42	289	60	413	22.5
X46	46	317	63	434	21.5

Note:

*: Table from CTC report “Existing Natural Gas Pipeline Materials and Associated Operational Characteristics (Hydrogen Regional Infrastructure Program in Pennsylvania)” [10]

Table 4. Elastomers in Natural Gas Distribution System*

	Material Name	Other Names	Type	Acronym
1	Butadiene-Styrene	Buna-S; GR-S	Styrene-butadiene Rubber	SBR
2	Butadiene-Acrylonitrile	Buna-N; Nitrile; Perbunan; Nytek	Acrylonitrile-butadiene Rubber	NBR
3	Natural Rubber	Gum	Natural Rubber	NR
4	Polychloroprene	Neoprene; Bayprene; Chloroprene	Synthetic Rubber	CR
5	Ethylene-Propylene	Nordel; Royalene; Dutral	Synthetic Rubber	EPM & EPDM
6	Polyamide (11 and 12)	Rilsan; Vydine; Plaskin; Nylon	PA11 & PA12 Elastomer	PA11 & PA12
7	Silicone and Fluorosilicone	Polysiloxanes; Cohrlastic; Green-Sil; Parshiled; Baysilone; Blue-Sil	Silicone Rubber/Polysiloxane	SI &FSI
8	Fluoroelastomer	Viton; Fluorel; Technoflon	High Performance Synthetic Rubber	FKM
9	Perfluoroelastomer	Kalrez; Chemraz; Kel-F	High Performance Synthetic Rubber	FPM
10	Polypropylene	PP	Thermoplastic/Polyolefin	PP
11	Polytetrafluoroethylene	Teflon, Halon	Fully Fluorinated Thermoplastic	PTFE &FTE

Note:

*: GTI internal data source

Table 5. Number of Leak Incidences by Causes for Distribution Mains and Services*

	Mains		Services	
	Number	%	number	%
Corrosion	55553	36.42	71963	21.64
Material Defect	10645	6.98	37124	11.16
Natural Force	12924	8.47	11305	3.40
Excavation	23475	15.39	82814	24.90
Other outside force	2834	1.86	13141	3.95
Equipment	10293	6.75	42279	12.71
Operation	3866	2.53	8557	2.57
Other	32956	21.60	65386	19.66
Total	152546	100.00	332569	100.00

Note:

*: Original data from DOT 2007 Annual Report [25]

Table 6. The cause of Transmission and Distribution Incidents*

Pipeline Safety Record Transmission and Distribution 1990-2002			Incidents by Cause						
			Corrosion	Outside Force	Construction/Operating Error	Accidentally Caused by Operator	Other	No Data	Total
Distribution	# of Incidents	Total Incident	59	954	97	84	378	7	1579
		Serious Incident	39	280	59	59	160	4	601
	% of Incidents	Total Incident	3.7	60.4	6.1	5.3	23.9	0.4	100
		Serious Incident	6.5	46.6	9.8	9.8	26.6	0.7	100
Transmission	# of Incidents	Total Incident	224	381	139	0	213	0	957
		Serious Incident	7	38	11	0	47	0	103
	% of Incidents	Total Incident	23.4	39.8	14.5	0.0	22.3	0.0	100
		Serious Incident	6.8	36.9	10.7	0.0	45.6	0.0	100

Note:

*: The data are from AGF report “Safety Performance and Integrity of the Natural Gas Distribution Infrastructure” [27].

Table 7. Coverage of Technology Areas in the Literature Database*

Technology Area	# of References	# of Reviews
Electrical Power-Coal	22	14
Electrical Power-Natural Gas	21	13
Electrical Power-Nuclear Power	10	7
Electrical Power-Oil	14	7
Electrical Power-Renewables	47	35
Electrical Power-Transmission and Distribution	9	9
Hydrogen-Network	13	14
Hydrogen-Production	48	60
Hydrogen-Utilization	11	9
Miscellaneous	6	5
Natural Gas Production, Network and Utilization	46	42
Natural Gas/Hydrogen Network and Utilization	5	3
Oil Production and Processing	13	6
Transport-Using Electricity	10	11
Transport-Using Hydrogen	32	33
Transport-Using Natural Gas	16	16
Transport-Using Oil	17	16
Transport-Using Renewable Energy	12	13

Note:

*: Table from NaturalHy Report “Literature Review Report on Life Cycle and Socio-Economic Assessment Aspects [1].

Table 8. Effect of Hydrogen Addition in Natural Gas on Gas Properties and Hazards*

Properties/Phenomena	Effect of Hydrogen Addition	Main Hazardous Hazards					
		Rupture	Explosion	Fire	Burns	Suffocation	Poisoning
Density	Lower					x	
Viscosity	Lower					x	
Velocity of Dispersion	About the same		x	x		x	
Hydrogen Component	Higher	x					x
Household Gas Pipe Leak Rate	Higher		x	+		x	
Lower flammability limit	About the same level		x	x			
Higher Flammability Limit	Higher		+				
Flammability Range	Wider		x				
Detonability Range	Wider		x				
Explosive Energy/Volume	Lower		x	x			
Explosive Energy/Mass	Higher		x	x			
Minimum Energy for Ignition	Lower		x	x			
Auto Ignition Temperature	Lower		x	+			
Uncontrolled Ignition	Easier		x	x			
Severity of Explosive Damage	Lower		x				
Explosion Risk in Confined Room	Higher		+				
Explosion Risk in unconfined Room	Lower		-				

Note:

*: Table from IEA report “Reduction of CO₂ Emissions by Adding Hydrogen to Natural Gas” [11]

x: hazard exists but unchanged by presence of hydrogen up to 15%

+: hazard increases by presence of hydrogen

-: hazard reduces by presence of hydrogen

Table 9. Ranking of the Hazards in Natural Gas Distribution Systems*

Significance of Hazard	Ranking Assigned
Severe	50
Moderate to Severe	40
Moderate	30
Minor to Moderate	20
Minor	10
None	0

Note:

*: The severity of the hazards is ranked with the numerical system generally used for risk assessment.

Table 10. The Risk Factor ^a for Pipe Material Categories and the Overall Risk Factor ^b at Each Failure Modes in Distribution Mains

Failure Mode	Pipe Material Categories and Their Percentage in Distribution Mains					Overall Risk Factor
	Steel	Cast Iron	PE	Other Plastics	Other	
	46.55%	3.14%	48.12%	2.06%	0.13%	
Corrosion	50	40	0	0	10	24.54
Material Defect	30	10	40	30	10	34.16
Natural Force	30	50	20	20	10	25.58
Excavation	50	50	50	50	50	50.00
Other Outside Force	10	10	10	10	10	10.00
Equipment	30	30	30	30	30	30.00
Operation	30	30	30	30	30	30.00
Other	10	10	10	10	10	10.00
Total	240	230	190	180	160	214

Note:

a: The hazard severity for each pipe material category was assessed at each failure mode by GTI based on the engineering experiences and the reported incident data in natural gas distribution system from 1990 to 2002 in AGF report “Safety Performance and Integrity of the Natural Gas Distribution Infrastructure” [27]. The risk factor for each material category in this table is assigned with the numerical definition of the hazard severity defined in Table 9.

b: The overall risk factor for each failure mode is calculated by the sum of the risk factor of each material category times the percentage of this material in distribution mains, see Equation (2).

Table 11. The Risk Factor ^a for Pipe Material Categories and the Overall Risk Factor ^b at Each Failure Modes in Service Lines

Failure Type	Pipe Material Categories and Their Percentage in Service Lines					Overall Risk Factor
	Steel	Cast Iron	PE	Other Plastics	Other	
	32.68%	0.17%	63.05%	0.42%	3.69%	
Corrosion	50	40	0	0	10	16.77
Material Defect	30	10	40	30	10	35.53
Natural Force	30	50	20	20	10	22.95
Excavation	50	50	50	50	50	50.00
Other Outside Force	10	10	10	10	10	10.00
Equipment	30	30	30	30	30	30.00
Operation	30	30	30	30	30	30.00
Other	10	10	10	10	10	10.00
Total	240	230	190	180	160	205

Note:

a: The hazard severity for each pipe material category was assessed at each failure mode by GTI based on the engineering experiences and the reported incident data in natural gas distribution system from 1990 to 2002 in AGF report “Safety Performance and Integrity of the Natural Gas Distribution Infrastructure” [27]. The risk factor for each material category in this table is assigned with the numerical definition of the hazard severity defined in Table 9.

b: The overall risk factor for each failure mode is calculated by the sum of the risk factor of each material category times the percentage of this material in service lines, see Equation (2).

Table 12. Risk Assessment for Distribution Mains at Three Hydrogen Levels

Failure Mode	Probability ^a (%)	Risk Factor				Overall Risk			
		NG ^b	< 20% H ₂ ^c	20 to 50% H ₂ ^c	>50% H ₂ ^c	NG ^b	<20% H ₂ ^c	20 to 50% H ₂ ^c	>50% H ₂ ^c
Corrosion	36.42	24.54	29.54	29.54	44.54	8.94	10.76	10.76	16.22
Material Defect	6.98	34.16	39.16	39.16	54.16	2.38	2.73	2.73	3.78
Natural Force	8.47	25.58	35.58	35.58	45.58	2.17	3.01	3.01	3.86
Excavation	15.39	50.00	60.00	70.00	70.00	7.69	9.23	10.77	10.77
Other Outside Force	1.86	10.00	15.00	15.00	30.00	0.19	0.28	0.28	0.56
Equipment	6.75	30.00	35.00	35.00	50.00	2.02	2.36	2.36	3.37
Operation	2.53	30.00	35.00	35.00	50.00	0.76	0.89	0.89	1.27
Other	21.60	10.00	15.00	15.00	30.00	2.16	3.24	3.24	6.48
Total	100.00	214	264	274	374	26	33	34	46

Note: The calculation of “Risk Factor” was performed by GTI

a: The probability of each failure mode is the statistical data of the leak incidents in distribution mains from DOT 2007 annual report [25], see Table 5.

b: The baseline risk factor for each failure mode in natural gas distribution mains, see Table 10.

c: The risk was assessed by GTI for each failure mode at different hydrogen levels in natural gas distribution mains compared with the baseline risk with natural gas. The risk factor at each level of hydrogen is calculated by adding the baseline risk factor with the increase of risk factor (Δ RF) at this hydrogen level, which is defined as below:

Δ RF=5: minor increase

Δ RF=10: minor to moderate increase

Δ RF=20: moderate to significant increase

Table 13. Risk Assessment for Distribution Services at Three Hydrogen Levels

Failure Mode	Probability ^a (%)	Risk Factor				Overall Risk			
		NG ^b	< 20% H ₂ ^c	20 to 50% H ₂ ^c	>50% H ₂ ^c	NG ^b	< 20% H ₂ ^c	20 to 50% H ₂ ^c	>50% H ₂ ^c
Corrosion	21.64	16.77	26.77	26.77	36.77	6.11	9.75	9.75	13.39
Material Defect	11.16	35.53	45.53	45.53	55.53	2.48	3.18	3.18	3.88
Natural Force	3.40	22.95	42.95	42.95	42.95	1.94	3.64	3.64	3.64
Excavation	24.90	50.00	70.00	90.00	100.00	7.69	10.77	13.85	15.39
Other Outside Force	3.95	10.00	20.00	20.00	30.00	0.19	0.37	0.37	0.56
Equipment	12.71	30.00	40.00	40.00	50.00	2.02	2.70	2.70	3.37
Operation	2.57	30.00	40.00	40.00	50.00	0.76	1.01	1.01	1.27
Other	19.66	10.00	20.00	20.00	30.00	2.16	4.32	4.32	6.48
Total	100.00	205	305	325	395	23	36	39	48

Note: The calculation of “Risk Factor” was performed by GTI

a: The probability of each failure mode is the statistical data of the leak incidents in service lines from DOT 2007 annual report [25], see Table 5

b: The baseline risk factor for each failure mode in natural gas service lines, see Table 11.

c: the risk was assessed by GTI for each failure mode at different hydrogen levels in natural gas service lines compared with the baseline risk with natural gas. The risk factor at each level of hydrogen is calculated by adding the baseline risk factor with the increase of risk factor (Δ RF) at this hydrogen level, which is defined as below:

Δ RF=5: minor increase

Δ RF=10: minor to moderate increase

Δ RF=20: moderate to significant increase

Δ RF=40: significant increase

Δ RF=50: significant increase at higher degree

Table 14. The Permeation Coefficient and the Calculated Gas Loss from a 32 mm (1.26") PE80 Pipe Under the Pressures of (58 psig (4 bar), 116 psig (8 bar) and 174 psig (12 bar))*

Gas	Pressure (psig)	Time-Lag (day)		Permeation Coefficient ($\times 10^{-3}$ ft ³ -mil/ft ² /day/psig)		Gas Loss (ft ³ /mile/year)		
		CH ₄	H ₂	CH ₄	H ₂	CH ₄	H ₂	Total
Pure CH ₄	58	6.46	NA	0.18	0	54.07	NA	54.07
90% CH ₄ + 10% H ₂	58	4.31	0	0.09	0.34	25.90	10.59	36.49
	116	6.39	0	0.12	0.50	67.03	31.04	98.07
	174	5.69	0	0.12	0.52	101.91	48.54	150.45

Note:

*: The original data in this table are from the experimental test results in the paper of "Evaluation of the Permeability to CH₄ and H₂ of PE Currently Used in Gas Distribution Networks" [18], and are converted to the English unit.

Table 15. Permeation Coefficient ($10^{-3} \times \text{ft}^3$ -mil/ft/day/psig) of Hydrogen Gas for Plastic Pipe Materials at 20°C*

Material	Experiment	Literature
PE80	1.50	1.99
MDPE	1.63	1.10
PE100	1.46	0.00
PEXa	3.37	0.00
PVC	0.91	0.69
Ductile PVC	0.97	0.00

Note:

*: The original data in this table are from IEA report “Reduction of CO₂ Emissions by Adding Hydrogen to Natural Gas” [11], and they are converted to the English unit.

Table 16. Permeation Coefficient ($10^{-3} \times \text{ft}^3 \text{-mil}/\text{ft}/\text{day}/\text{psig}$) of Hydrogen in Plastic Pipe and Elastomeric Materials

Material	Hydrogen	Methane
MDPE (PE2708) ^a	1.43	0.29
HDPE (PE3608) ^a	1.09	0.16
HDPE (PE4710) ^a	1.09	0.16
PVC ^a	0.95	NA
Natural Rubber ^b	28.39	NA
Butyl Rubber ^b	4.27	NA
Buna S (SBR) ^b	23.02	NA
Neoprene (CR) ^b	7.67	NA
Buna N (NBR) ^b	9.12	NA

Note:

a: Data are from “AGA Handbook: Plastic Pipe Manual for Gas Service” [29]

b: Data are from EIA report “Hydrogen Transportation Pipeline” [13]

Table 17. The Calculated Gas Loss Rate (ft³/mile/year) Based on Literature Data for HDPE Pipes at the Operating Pressures of 60 psig, 3 psig and 0.25 psig*

Hydrogen Content	At 60 psig			At 3 psig			At 0.25 psig		
	H ₂	CH ₄	Total	H ₂	CH ₄	Total	H ₂	CH ₄	Total
0%	0.0	49.4	49.4	0.0	2.5	2.5	0.0	0.2	0.2
10%	32.9	44.5	77.4	1.6	2.2	3.9	0.1	0.2	0.3
20%	65.9	39.5	105.4	3.3	2.0	5.3	0.3	0.2	0.4
50%	164.7	24.7	189.4	8.2	1.2	9.5	0.7	0.1	0.8
100%	329.3	0.0	329.3	16.5	0.0	16.5	1.4	0.0	1.4

Note: The calculation was performed by GTI.

*: The data in this table are calculated by Equation (2) using the permeation coefficient data in Table 16 from “AGA Handbook: Plastic Pipe Manual for Gas Service” [29].

Table 18. Classification of Hydrogen Degradation of Metals*

Type of Damage	Hydrogen Embrittlement			Hydrogen Attack	Blistering
	Environment Embrittlement	Stress Cracking	Loss in Tensile Ductility		
Typical Materials	Steels, nickel-base alloys, metastable stainless steel, titanium alloys	Carbon and low-alloy steels	Steels, nickel-base alloys, Be-Cu bronze, aluminum alloys	Carbon and low-alloy steels	Steels, copper, aluminum
Hydrogen Source	Gaseous H ₂	Thermal processing, electrolysis, corrosion	Gaseous H ₂ , internal hydrogen from electrochemical charging	Gaseous	Hydrogen sulfide corrosion, electrolytic charging, gaseous
Typical Conditions	10 ⁻¹⁰ to 10 ⁴ gas pressure	0.1 to 10 ppm total hydrogen content	0.1 to 10 ppm H ₂ of gas pressure exposure	Up to 15 ksi	Hydrogen activity equivalent to 3-15 ksi
	Observed at -150 to 1290°F Most severe at 70°F	Observed at -150 to 210°F Most severe near 70°F	Observed at -150 to 1290°F	400-1100°F	30-300°F
	More severe at low strain rate	More severe at low strain rate	Strain rate important		
Type of Damage	Shatter Cracks, Flakes, Fisheyes	Micro-Perforation	Degradation in Flow Properties	Metal Hydride Formation	
Typical Materials	Steels (forgings and castings)	Steels (compressors)	Iron, steels, nickel-base alloys	Vanadium, Niobium, Tantalum, Titanium, Zirconium, Uranium	
Hydrogen Source	Water vapor reacting with molten steel	Gaseous hydrogen	Gaseous or internal hydrogen	Internal hydrogen from melt; corrosion, electrolytic charging, welding	
Typical Conditions	Precipitation of dissolved ingot	30-125 ksi	1-10 ppm hydrogen content at 70°F for iron or steels	15-15,000 psig gas pressure	
	Cooling	70-210°F	Up to 15 ksi gaseous hydrogen at T > 0.5 melting point for various metals	Hydrogen activity must exceed solubility limit near 70°F	

Note:

*: Table from ASM Handbook Vol. 13A (Hydrogen Damage) [28]

Table 19. Hydrogen Compatibility of the Plastics and Elastomers Used in Natural Gas Pipeline*

Polymers	Compatibility
Polyethylene	Good
Polyvinyl Chloride	Good
Natural Rubber	Fair
Butyl Rubber	Good
Silicone Rubber	Fair
Neoprene (CR)	Good
Buna S (SBR)	Good
Viton	Good
Buna N (NBR)	Good

Note:

*: Data from EIA report “Hydrogen Transportation Pipelines” [13] and PPI report “Chemical Resistance of Thermoplastics Piping Materials” [31]

Table 20. Operator Perceptions on Threat Significance*

Threat Priority	Threat	% of Respondent
1	Outside Force/Weather Cast Iron Pipe	90
2	Excavation/Mechanical Damage	87
3	External Corrosion Bare Steel Pipe	86
4	External Corrosion (Graphitization) Cast Iron Pipe	71
5	External Corrosion Coated & Wrapped Pipe	69
6	Construction-Related Defects Plastic Pipe	57
7	Outside Force/Weather Steel Pipe	49
8	Construction-Related Defects Steel Pipe	48
9	Incorrect Operations & Operator Error	35
10	Equipment Malfunction	35
11	Manufacture-Related Defects Plastic Pipe	30
12	Outside Force/Weather Plastic Pipe	26
13	Internal Corrosion	22
14	Manufacture-Related Defects Plastic Pipe	22

Note:

*: Table from AGF report “Safety Performance and Integrity of the Natural Gas Distribution Infrastructure” [27]. The identified threats in natural gas distribution systems are prioritized in this table according to the response from the survey performed by AGF with the utility operators. The higher priority is given to the threat accepted by more respondents.

References

	Ref #	Outline	Pub. Yr	Task #	Author and Affiliation
NaturalHy Report	1	<p>Literature Review Report on Life Cycle and Socio-Economic Assessment Aspects</p> <p>Compare the current energy system, transition natural gas/hydrogen system, and future complete hydrogen system in terms of:</p> <ol style="list-style-type: none"> 1. Primary energy inputs vs. energy resource depletion 2. Environmental impact: <ul style="list-style-type: none"> • Greenhouse gas emissions associated with climate change, • Other gases: NO_x, SO₂, PM₁₀, etc., • Liquid and solid emissions associated to acidification, ozone depletion and eutrophication, 3. Direct and indirect job creation and maintenance, and 4. Economic costs. 	2004	4.1 4.7	<ol style="list-style-type: none"> 1. N. D. Mortimer and R. E. Horne U. of Warwick, UK 2. K. A. Adamson Technical U., Germany 3. T. Bouquet, S. Minett and S. Craenen, COGEN Europe, Belgium 4. A. de Groot, ISQ, Portugal 5. T. Feck, K. Stolzenburg and R. Steinberger-Wilckens Energy Research Centre of the Netherlands 6. P. Helb, SAVIKO Consultants ApS, Denmark
	2	<p>What are the Life Cycle Analysis and Socio-Economic Issues (final presentation)</p> <p>Identify the issues related to using hydrogen as primary energy source:</p> <ul style="list-style-type: none"> • Emissions, • Employment, and • Cost 	2009	4.1 4.7	Nigel Mortimer Loughborough University, UK
	3	<p>Adding Hydrogen to the Natural Gas Infra-Structure - Assessing the Risk to the Public (final presentation)</p> <ol style="list-style-type: none"> 1. Consequences of accidental releases (large scale experiments and mathematical models): <ul style="list-style-type: none"> • Gas buildup, • Fire, and • Explosion. 2. Failure frequency and ignition probability (engineering judgment and information for durability and integrity work packages). 3. Assess risk to public: <ul style="list-style-type: none"> • Transmission pipeline failures, and • Explosions in domestic properties. 	2009	4.2 4.3	Barbara Lowesmith Loughborough University, UK

	Ref #	Outline	Pub. Yr	Task #	Author and Affiliation
NaturalHy Report	4	Assessment of Repair and Rehabilitation Technologies Relating to the Transport of Hythane: <ol style="list-style-type: none"> 1. Assess the suitability of the existing repair and rehabilitation technologies for distribution and transmission pipelines: <ul style="list-style-type: none"> • Operation pressure within 10 bars • 50% hydrogen in hythane 2. Consequences of repair technologies: <ul style="list-style-type: none"> • Technological • Economical. 	2006	4.5	Jens Huttenrauch and Gert Muller-Syring DBI-GUT
	5	How Does the Presence of Hydrogen Effect Pipeline Integrity and What Can We Do About It? (final presentation) <ul style="list-style-type: none"> • When and how to inspect and repair • Specification for an integrity management tool • Software development to calculate probability of failure (POF) • Cost of integrity management by hydrogen addition. 	2009	4.5	Gert Müller-Syring, DBI-GUT
	6	Principles of Resource Allocation Relating to Pipeline Integrity Management (for transmission pipeline).	2008	4.5	Lise Lanarde GDF SUEZ, France
	7	Interim Report on Membrane Development for Hydrogen Separation: <ul style="list-style-type: none"> • Specifications and target for membrane development • Pd based membrane development (Interim) • Carbon based membrane development (Interim). 	2007	4.6	D. F. Uoxf NTUN, CETH
	8	To What Extend Can Existing Pipelines Accommodate Hydrogen? (final presentation) <ol style="list-style-type: none"> 1. Assess the impact of H₂ on transmission pipelines 2. Assess the impact of H₂ on distribution network <ul style="list-style-type: none"> • Permeability of PE and PVC • Aging of PE • Reliability of domestic gas meters. 	2009	4.4	Isabelle Alliat GDF SUEZ
	9	Decision Support Tool (final presentation) <ul style="list-style-type: none"> • Provide the assessment and suitability of adding hydrogen to NG systems in the Netherlands • The results and conclusions of this task are not included in this presentation. 	2009	Go/no go decision	Peter Bartlam ISO, Portugal

	Ref #	Outline	Pub. Yr	Task #	Author and Affiliation
CTC Report	10	<p>Existing Natural Gas Pipeline Materials and Associated Operational Characteristics (hydrogen regional infrastructure program in Pennsylvania):</p> <p>Compare the natural gas pipelines in the U.S. and PA and assess the feasibility of co-transporting hydrogen and natural gas in terms of:</p> <ul style="list-style-type: none"> • Pipeline materials • Operating conditions • Piping components • Losses and leakage • Pipeline security. 	2005	4.2 4.3 4.4 4.6	Concurrent Technologies Corp., PA, US
IEA Green House Gas R&D Program	11	<p>Reduction of CO₂ Emissions by Adding Hydrogen to Natural Gas:</p> <ol style="list-style-type: none"> 1. Review the effect of adding hydrogen in natural gas on the safety, economy, environment and the requirement for upgrades to the natural gas network and end user appliances. 2. Review the percentage of hydrogen in NG/H₂ blends and the potential for a three step sequence to phase hydrogen into natural gas pipeline. 3. Review the potential non-technical barriers from the standpoint of economy, psychology or emotion that may hinder the introduction of hydrogen as a substantial energy carrier. 	2003	4.1-4.7	E. A. Polman, J.C. de Laat, M. Crowther et al. GASTEC Technology BV, Netherlands
	12	<p>Present Status of Hydrogen Transport Systems-Using Existing Natural Gas Supply Infrastructures in Europe and the USA</p> <p>A review on the worldwide hydrogen infrastructure-related projects and the status as related to transporting hydrogen using existing natural gas networks.</p>	2005	4.1-4.7	Takeo Suzuki, Shin-ichiro Kawabata, Tetsuji Tomita, Institute of Energy Economics, Japan (IEEJ)
	13	<p>Hydrogen Transportation Pipelines</p> <p>A document on design, construction, and operational requirements for hydrogen transportation pipelines.</p>	2004	4.4	European Industrial Gases Association

	Ref #	Outline	Pub. Yr	Task #	Author and Affiliation
EET Project	14	<p>Mixing and Transportation of H₂ via the NG Network in Rozenburg</p> <p>Study of the bottlenecks and advantages/disadvantages of mixing and transporting hydrogen via the existing natural gas infrastructure from technical, institutional, and economical aspects of Rozenburg.</p>	2008	4.3 4.4 4.7	Anish Patil Delft U. of Technology, Netherlands
	15	<p>The Use of the Natural Gas Pipeline Infrastructure for Hydrogen Transport in a Changing Market Structure</p> <p>Discusses the energetic and material aspects of hydrogen transport through existing natural gas pipeline.</p>	2006	4.4 4.7	Dries Haeseldoncks, William D'haeselleer, U. of Leuven, Belgium
NaturalHy Project	16	<p>Assess the Durability and Integrity of Natural Gas Infrastructure for Hydrogen and Natural Gas Blends</p> <ol style="list-style-type: none"> Discusses the durability of steel, PE, and gas meters with H₂: <ul style="list-style-type: none"> H₂ embrittlement and its effect on toughness and fatigue, Permeability of H₂ in PE and aging of PE in H₂, and Accuracy of gas meter (polymer membrane), leakage, and durability. Integrity Management for H₂/natural gas mixture: <ul style="list-style-type: none"> Defect criticality may change with H₂ content, Development of inspection tools, Development of repair strategies, and Development of integrity management tool. 	2005	4.4 4.5	Isabelle Alliat, J. Heerings, GAZ De France, France
NaturalHy Project	17	<p>The Value of the Existing Natural Gas System for Hydrogen:</p> <ol style="list-style-type: none"> Overview of NaturalHy projects, Durability of steel, PE and gas meters with H₂, Integrity management for H₂/natural gas mixture, and Risks with H₂ in natural gas pipeline. 	2006	4.2 4.3 4.4 4.5	1. O Florisson, Gasunie Engineering & Technology, Netherlands 2. Isabelle Alliat, GAZ De France, France
NaturalHy Project	18	<p>Evaluation of the Permeability to CH₄ and CH₄+H₂ of PE Currently Used in Gas Distribution Networks.</p> <p>Experimental evaluation of the permeability of CH₄ and CH₄+10%H₂ in PE 63, PE80, and PE100 under operating temperatures and pressures.</p>	2008	4.3 4.4	1. D. Gueugnaut, and Denise rousset, GAZ De France, France 2. G. Tari, Degaz, Hungary 3. A. Drdöhelyi, Szeged U., Hungary

	Ref #	Outline	Pub. Yr	Task #	Author and Affiliation
	19	Study of the Behavior of Gas Distribution Equipment in Hydrogen Service-Phase II Leakage measurements with hydrogen/natural gas mixtures on natural gas distribution system	1980	4.3	Walter J. Jasionowski, GTI, USA
	20	Pathways to a Hydrogen Society The diffusion coefficients of hydrogen in Polyethylene (medium density, high density, PE100, crosslinked polyethylene) and Polyvinyl Chloride from literatures and laboratory measurements	2002	4.3	E.A. Polman, A. van Wingerden, M. Wolters GASTEC Technology BV, Netherlands
	21	ASME B31.8-2007 Gas Transmission and Distribution Piping Systems	2007	4.2 4.5	The American Society of Mechanical Engineers
	22	API 5L (API Specification for Line Pipe)	2004	4.4	American Petroleum Institute
	23	ASME B31.12-2008 Hydrogen Piping and Pipeline	2008	4.4	The American Society of Mechanical Engineers
	24	49 CFR Part 192 Pipeline Safety: Integrity Management Program for Gas Distribution Pipelines (Final Rule)	2009	4.2 4.5	Department of Transportation Pipeline and Hazardous Materials Safety Administration
	25	DOT 2007 Annual Distribution Data	2007	4.2 4.3 4.5	Department of Transportation Pipeline and Hazardous Materials Safety Administration
	26	Integrity Management for Gas Distribution (Report of Phase 1 Investigation)	2005	4.2 4.5	Department of Transportation Pipeline and Hazardous Materials Safety Administration
	27	Safety Performance and Integrity of the Natural Gas Distribution Infrastructure	2005	4.2 4.5	URS Corporation American Gas Foundation
	28	ASM Handbook Vol. 13A (Hydrogen Damage)	2003	4.4	ASM International
	29	Plastic Pipe Manual for Gas Service (8th edition)	2006	4.3	American Gas Association
	30	Permeation, Solubility and Interaction of Hydrogen in Polymers- An Assessment of Materials for Hydrogen Transport	2008	4.4	Savannah River National Lab
	31	Chemical Resistance of Thermoplastics Piping Materials	2007	4.5	Plastic Pipe Institute

List of Acronyms

Acronym	Description
ABS	Acrylonitrile Butadiene Styrene
AGA	American Gas Association
AGF	American Gas Foundation
API	American Petroleum Institute
ASM	American Society for Metals
ASME	American Society of Mechanical Engineers
CCS	Carbon Capture Storage
CETE	Compagnie Europeenne des Technologies del'Hydrogene
CFD	Computational Fluid Dynamic
CFR	Code of Federal Regulations
CI	Cast Iron
CMS	Carbon Molecular Sieves
CP	Cathodic Protection
CTC	Concurrent Technology Corporation
DCC	Dutch Corrosion Center
DDT	Deflagration to Detonation Transition
DIMP	Distribution Integrity Management Program
DIMP	Distribution Integrity Management Program
DOE	Department of Energy
DOT	Department of Transportation
ECN	The Energy Research Center
EET	Dutch Economy, Ecology and Technology
GTI	Gas Technology Institute
HDPE	High Density Polyethylene
IEEJ	Institute of Energy Economics Japan
IMT	Integrity Management Tool
IEA	International Energy Agency

List of Acronyms

Acronym	Description
IMP	Integrity Management Program
ISQ	Instituto de Soldadura e Qualidade
LDCs	Local Distribution Companies
LNG	Liquefied Natural Gas
MDPE	Medium Density Polyethylene
MM	Mixed Matrix
NBR	Butadiene-Acrylonitrile
NREL	National Renewable Energy Laboratory
NTNU	Norwegian University of Science and Technology
OPS	Office of Pipeline Safety
PE	Polyethylene
PHMSA	Pipeline and Hazardous Materials Safety Administration
POF	Probability of Failure
PSA	Pressure Swing Adsorption
PVC	Polyvinyl Chloride
SBR	Butadiene-Styrene
SCC	Stress Corrosion Cracking
SMYS	Specified Minimum Yield Strength
UV	Ultraviolet
VCE	Vapor Cloud Explosion
WI	Wrought Iron

END OF TABLE